



SPECIALIZED FABRICATION EQUIPMENT GROUP

PRODUCT SUMMARY

**MATHEY DEARMAN**  
Where There's Pipe, There's Mathey!

PIPE FLAME CUTTING AND BEVELLING



PIPE ALIGNMENT AND REFORMING CLAMPS



PIPE RIGGING EQUIPMENT



[www.MATHEY.COM](http://www.MATHEY.COM)

**B&B Pipe & Industrial Tools**  
The Pipe Fabricators Source

PIPE JACK AND STANDS



MEGA ROLLERS AND STANDS



MATERIAL HANDLING EQUIPMENT



[www.BBPIPETOOLS.COM](http://www.BBPIPETOOLS.COM)

**TAG**  
PIPE EQUIPMENT SPECIALISTS  
World Leading Manufacturer of Pipe Beveling and Cutting Machines

PIPE BEVELLING MACHINES



PIPE COLD CUTTING MACHINES



[www.TAG-PIPE.COM](http://www.TAG-PIPE.COM)

**AXXAIR**  
Innovative Orbital Solutions

ORBITAL CUTTING / BEVELLING AND FACING



ORBITAL WELDING



[www.AXXAIR.COM](http://www.AXXAIR.COM)

**PPM PIPE PURGE MASTERS**  
Purging Solutions for the perfect pipe weld!

PIPE PURGING SYSTEMS



PURGE OXYGEN MONITOR



PIPE STOPPERS



[www.PURGEMASTERS.COM](http://www.PURGEMASTERS.COM)

**FIT-UP PRO**  
By Mathey Dearman  
The Pipe Fitters Companion

FIT-UP AND ALIGNMENT TOOLS



LAYOUT AND MARKING TOOLS



[www.FIT-UP-PRO.COM](http://www.FIT-UP-PRO.COM)



## SPECIALIZED FABRICATION EQUIPMENT GROUP

### Introduction to S.F.E. Group

S.F.E. Group was founded in 2019 after the merger of three world leading OEM's in the field of pipe fabrication tooling and machinery: B&B Pipe and Industrial Tools LLC (USA), Mathey Dearman Inc. (USA) and TAG Pipe Equipment Specialists (UK). The most recent acquisition dates back to the start of 2022 when the Axxair Group was added to the S.F.E. Group.

S.F.E. Group offers a wide range of products and is continuously exploring new product design and development, as well as add-on acquisitions to enhance its portfolio and to fulfil increasing industries' demands.

With offices and warehousing on 4 continents, 120 employees and more than 250 partnerships and distributors worldwide, S.F.E. Group prides itself in consistently offering the highest standard of both product quality and service to all its customers.

S.F.E. Group looks forward to welcoming you into its global network as a partner, distributor or end user customer and remains at your disposal at any time.



S.F.E. GROUP HEAD OFFICE - USA



S.F.E. GROUP HEAD OFFICE - FRANCE

### OUR BRANDS

 <b>MATHEY DEARMAN</b> Where There's Pipe, There's Mathey! PIPE FLAME CUTTING AND BEVELLING PIPE ALIGNMENT AND REFORMING CLAMPS PIPE RIGGING EQUIPMENT <a href="http://www.MATHEY.COM">www.MATHEY.COM</a>	 <b>B&amp;B Pipe &amp; Industrial Tools</b> The Pipe Fabricators Source PIPE JACK AND STANDS MEGA ROLLERS AND STANDS MATERIAL HANDLING EQUIPMENT <a href="http://www.BBPIPETOOLS.COM">www.BBPIPETOOLS.COM</a>	 <b>TAG</b> PIPE EQUIPMENT SPECIALISTS World Leading Manufacturer of Pipe Beveling and Cutting Machines PIPE BEVELLING MACHINES PIPE COLD CUTTING MACHINES <a href="http://www.TAG-PIPE.COM">www.TAG-PIPE.COM</a>	 <b>AXXAIR</b> Innovative Orbital Solutions ORBITAL CUTTING / BEVELLING AND FRACING ORBITAL WELDING <a href="http://www.AXXAIR.COM">www.AXXAIR.COM</a>	 <b>PPM</b> PIPE PURGE MASTERS Purging Solutions for the perfect pipe weld! PIPE PURGING SYSTEMS PURGE OXYGEN MONITOR PIPE STOPPERS <a href="http://www.PURGEMASTERS.COM">www.PURGEMASTERS.COM</a>	 <b>FIT-UP PRO</b> By Mathey Dearman The Pipe Fitters Companion FIT-UP AND ALIGNMENT TOOLS LAYOUT AND MARKING TOOLS <a href="http://www.FIT-UP-PRO.COM">www.FIT-UP-PRO.COM</a>
---	---	---	---	---	--



### Customer service

We work extremely hard supporting and training our team of employees and network of partners and distributors to ensure that from The S.F.E. Group you always receive the:

- Fastest response times
- Quickest delivery times
- Most knowledgeable and accurate advice
- Committed after sales support



### Level of stock

S.F.E. Group carry an unrivalled stock level, meaning no matter how large your order we expect to offer you the fastest delivery time available worldwide.

### Price

You will find our pricing to be very competitive. Give us an opportunity to quote your next project and we are confident you will be pleased! For your convenience we offer our products in the three major currencies: US Dollar, Euro and GB Pound.



### Research and development

Technology is always improving. At S.F.E. Group we firmly intend to move with the times and to be the innovators in our industry with a dedicated team of designers and technicians devoted to improving our existing products as well as innovating the next generation of pipework machinery and tools. All user feedback is passed onto the R&D department to ensure our machines are developed to meet all end user needs. We often hold meetings with customers to ensure the package provided meets all their requirements including custom made machines.

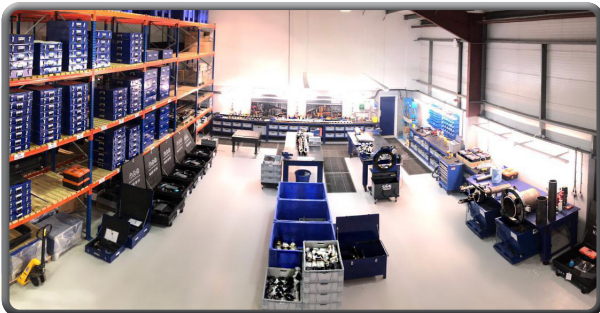

### Production, assembly and quality control

S.F.E. Group is proud to offer the highest quality of components manufactured wholly in Europe/USA. All our machines are assembled in our facilities and undergo vigorous testing and quality control, which is backed by our products being CE Certified, having Certificates of Conformity, Certificates of Origin and our company being ISO9001 accredited.



### Demonstrations, training and exhibitions

We love to show off our products unrivalled performance and are always happy to carry out demonstrations either in our showroom facilities or at your site. In addition we understand the importance of the correct operation of our machinery and tools, so also offer training packages in our training facilities or at your site ensuring safe, efficient and accurate operation. We also participate in all the relevant world wide exhibitions. We also have extremely detailed user manuals and instructional videos.



### Rental division

The S.F.E. Group operates a full, worldwide hire and rental service in cooperation with and supported by its selected and specialized rental partners. S.F.E. Group continuously keeps expanding its rental activities, rental fleet and network and prides itself keeping its renting equipment up to date in order to provide the best possible quality, performance and reliability. S.F.E. Group invites you to share your rental enquiry and will tailor the matching solution to your needs.

**Please contact your local S.F.E. Group branch for all enquiries.  
Details of which can be found on the back cover of this publication.**

# TABLE OF CONTENTS

<b>Introduction to S.F.E. Group.....</b>	<b>2</b>	<b>B&amp;B Material handling equipment .....</b>	<b>15</b>	<b>Product over &gt; 3mm .....</b>	<b>25</b>
<b>Introduction to Mathey Dearman .....</b>	<b>5</b>	B&B Pipe cart .....	15	AXXAIR Orbital cutting .....	25
<b>Mathey Dearman Pipe flame cutting and bevelling.....</b>	<b>6</b>	B&B Bundle cart .....	15	AXXAIR Tube bevelling .....	25
MATHEY Saddle Machine motorized / manual .....	6	B&B Crate cart .....	15	AXXAIR Orbital welding: power source .....	25
MATHEY E-Z Pipecut Manual .....	6	B&B Conduit carts .....	16	AXXAIR Orbital welding: prefabrication .....	26
MATHEY E-Z Pipecut Auto .....	6	B&B Stake cart .....	16	AXXAIR Orbital welding: open heads .....	26
MATHEY E-Z Pipecut Magnetic .....	6	B&B Hanger carts .....	16	AXXAIR Orbital welding: tube to tubesheet .....	26
MATHEY Band Crawler cutting and bevelling machine .....	6	B&B Baby pipe buggy .....	16		
		B&B Biggy pipe buggy .....	16	<b>Introduction to Pipe Purge Masters (PPM) .....</b>	<b>27</b>
		B&B Cylinder / Bottle carts .....	16	<b>Pipe Purging Systems.....</b>	<b>28</b>
<b>Mathey Dearman Pipe alignment and reforming clamps.....</b>	<b>7</b>			PPM Purge bag systems .....	28
MATHEY Sturdi pipe chain clamp .....	7	<b>Introduction to TAG Pipe Equipment Specialists.....</b>	<b>17</b>	PPM Rapid purge™ system .....	28
MATHEY Double jackscrew chain clamp.....	7	<b>TAG PREP Pipe Bevelling Machines .....</b>	<b>18</b>	PPM Heat resistant purging systems.....	28
MATHEY Double chain pipe clamp .....	7	TAG PREP 2 Pipe Bevelling ½" to 1½" .....	18	PPM Double seal systems.....	28
MATHEY Rim clamp .....	7	TAG PREP 3 Pipe Bevelling 1" to 3" .....	18		
MATHEY Manual lever cage clamp .....	8	TAG PREP 4 Pipe Bevelling 1" to 4" .....	18	<b>Pipe Purging Monitors.....</b>	<b>29</b>
MATHEY Ratchet cage clamp.....	8	TAG PREP 8 Pipe Bevelling 2" to 8" .....	18	PPM Handy purge 100SC self calibrating	
MATHEY Hydraulic cage clamp .....	8	TAG PREP 16 Pipe Bevelling 3" to 16" .....	19	weld purge monitor .....	29
MATHEY Super clamp .....	8	TAG PREP 24 Pipe Bevelling 7" to 24" .....	19		
MATHEY Sleeve clamp .....	9	TAG PREP 16 and PREP 24 elbow fitting machines.....	19	<b>Pipe Stoppers .....</b>	<b>29</b>
		TAG Panel prep machines.....	19	PPM Expanding pipe stoppers - nylon .....	29
<b>Mathey Dearman Pipe rigging equipment .....</b>	<b>9</b>			PPM Expanding pipe stoppers - aluminium .....	29
MATHEY Slings and cradles .....	9	<b>TAG Pipe Cold Cutting Machines .....</b>	<b>20</b>	PPM Expanding pipe stoppers - steel .....	29
MATHEY Pipe launchers .....	9	TAG Split frame clamshell cold cutting		PPM Inflatable pipe stoppers .....	29
MATHEY Beam clamp rollers .....	9	and bevelling machines 1" to 48" .....	20		
		TAG Split frame clamshell cold cutting		<b>Introduction to Fit-Up Pro.....</b>	<b>30</b>
<b>Introduction to B&amp;B Pipe and Industrial Tools.....</b>	<b>10</b>	and bevelling machines 48" to 120" .....	20	<b>Fit-Up and Alignment Tools.....</b>	<b>31</b>
<b>B&amp;B Pipe jacks and stands .....</b>	<b>11</b>	TAG E-Z FAB pipe cutting and bevelling		FIT-UP PRO Quick fit PDQ pipe clamps .....	31
B&B Fixed pipe jack (tri pipe stand) .....	11	machines 1" to 24" .....	20	FIT-UP PRO E-Z fit gold pipe clamps .....	31
B&B Folding pipe jack (tri pipe stand) .....	11	TAG E-Z pipe saw 1" to 12" .....	20	FIT-UP PRO E-Z fit spider internal clamp	
B&B Six-foot folding pipe jack .....	11			- spider clamp - series 400 .....	31
B&B Duo pipe stand .....	11	<b>TAG Plate Bevelling Machines.....</b>	<b>21</b>	FIT-UP PRO E-Z fit spider internal clamp	
B&B Adjustable Pipe Roller .....	12	TAG PMM155 .....	21	- elbow spider clamp - series 500 .....	31
B&B Multi-roll Pipe Roller .....	12	TAG PMM200 .....	21	FIT-UP PRO E-Z fit spider internal clamp	
B&B 3 Leg giant jack.....	12	TAG PMM200SS.....	21	- scissor clamp - series 100 .....	32
B&B 5 Leg giant jack.....	12			FIT-UP PRO Spacing wedges .....	32
B&B Roller stands (heavy duty).....	13	<b>Introduction to AXXAIR .....</b>	<b>22</b>	FIT-UP PRO Flange spreader .....	32
B&B Quick change rollers .....	13	<b>Product under &lt; 3mm.....</b>	<b>23</b>	FIT-UP PRO Flange alignment bolts (FAB Bolts).....	33
B&B Uno pipe jacks stand .....	13	AXXAIR Orbital cutting (eco range) .....	23	FIT-UP PRO Push-button carbon steel flange line up pins .....	33
B&B Tri-stand chain vice.....	13	AXXAIR Orbital cutting .....	23	FIT-UP PRO Stainless steel flange pins.....	33
		AXXAIR Tube squaring .....	23	FIT-UP PRO Rotary earth clamp.....	33
<b>B&amp;B Mega rollers and stands .....</b>	<b>14</b>	AXXAIR Orbital welding: power source .....	23		
B&B Mega rollers - 6,000 lbs. 3 US ton .....	14	AXXAIR Orbital welding: prefabrication .....	24	<b>Layout and Marking Tools.....</b>	<b>34</b>
B&B Mega rollers - 10,000 lbs. 5 US ton .....	14	AXXAIR Orbital welding: microfit heads .....	24	FIT-UP PRO Centering head.....	34
B&B Mega rollers - 15,000 lbs. 7 US ton .....	14	AXXAIR Orbital welding: closed heads .....	24	FIT-UP PRO Pocket level .....	34
B&B Mega jack - 3 leg and 4 leg .....	14	AXXAIR Orbital welding: open heads .....	24	FIT-UP PRO Torpedo level .....	34
B&B Mega block.....	15	AXXAIR Orbital welding: tube to tubesheet.....	25	FIT-UP PRO Radius marker.....	34
B&B Mega horse .....	15			FIT-UP PRO Q.C. Welder with pit gauge.....	34
				FIT-UP PRO Pipe wrap.....	35
				FIT-UP PRO Pipe fitter's square .....	35
				FIT-UP PRO Protractors.....	35
				FIT-UP PRO Framing square.....	35
				FIT-UP PRO Flange square .....	35



## SPECIALIZED FABRICATION EQUIPMENT GROUP

*Our group policy is one of continuous improvements and acquisitions.  
Products and data tables are subject to change and may vary from those illustrated.*

### OUR BRANDS





## Introduction to Mathey Dearman

The company Mathey Dearman was originally founded in the United States in the 1930's. During the first decades its founder C.A Mathey developed patented saddle-type portable pipe cutting and bevelling machines and clamping, aligning and reforming systems for pipes. Mathey Dearman became rapidly a worldwide recognized authority within its field and is still today setting the benchmark and being the point of reference for many applications.

With the merger in 2019 of B&B Pipe and Industrial Tools LLC (USA), Mathey Dearman Inc. (USA) and TAG Pipe Equipment Specialists (UK) and the recent addition in 2022 of AXXAIR (France) into Specialized Fabrication Equipment (S.F.E.) Group, the various product groups offered by the original manufacturers have been re-aligned and integrated into the overall S.F.E. Group product range whilst keeping their own brand identity.

The Mathey Dearman brand portfolio consists of a comprehensive range of pipe equipment: **pipe flame cutting and bevelling machines, pipe alignment and reforming clamps, pipe rigging equipment and Fit-Up Pro's range of fit-up, alignment, layout and marking tools.**

With the Mathey Dearman brand, S.F.E. Group not only wishes to highlight the focus on this particular product line, but also supply the growing demand and diverse applications in the industries that it already serves and intertwine with other product applications within S.F.E. Group.

As an OEM and backed with over 80 years of development, S.F.E. Group prides itself being renowned for its innovations, ground-breaking developments and creative designs within the Mathey Dearman product range. With its engineering capabilities, customer-oriented focus and flexibility, the Mathey Dearman brand provides the possibility to design out-of-the-box pipe machining and tooling solutions to fulfil customers' projects' specific needs in particular and to cater for an ever-evolving industry in general.

Mathey Dearman products are available from the international S.F.E. Group branches on 4 continents, as well as from S.F.E. Group's extensive and continuously expanding global network of partners and distributors.

**Where there's pipe, there's Mathey.**  
**Get in touch for all your piping applications.**



### PIPE FLAME CUTTING AND BEVELLING



Mathey Dearman manufactures multiple flame and plasma pipe cutters and bevellers and are recognized as the leader in this product category. These machines are used across multiple fabrication projects, most commonly found in the energy construction markets.

### PIPE ALIGNMENT AND REFORMING CLAMPS



With continuous improvement and new additions, Mathey Dearman is now offering the most complete line in the industry of pipe alignment and reforming clamps.

### PIPE RIGGING EQUIPMENT

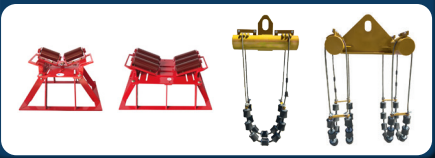

A new line of pipe rigging products is offered under the Mathey Dearman brand. Pipe slings and cradles, pipe launchers and rigging rollers add focus on a complimentary pipeline product category to Mathey Dearman's range of aligning and reforming clamps and flame and plasma pipe cutting and bevelling machines.



## MATHEY Saddle Machine motorized / manual

**1½" - 48" (48.2 mm - 1,219 mm) o/d**

Designed for cutting and beveling fish mouth, shapes and contours on pipes. Our short saddle machines are the only single piece, short saddle machine on the market, providing you with consistently square and accurate cuts - cut after cut - year after year. Our short saddle machines can be used for plasma or water jet cutting. They are designed to be dropped on the pipe like a saddle or slipped on from the end.

\* Accessories are required to perform the shapes. (Attachment + template)



## MATHEY E-Z Pipecut Manual

**4" (114 mm) upwards**

Mathey Dearman's E-Z Pipecut portable oxy-fuel cutting and beveling chain driven machines are the economical solution for cutting and beveling pipe with wall thickness 5 mm up to 50 mm. The Mathey Dearman E-Z Pipecut Manual is small and compact, strong and reliable, used by contractors, welders and pipe fitters, equally on-site or in the workshop. The E-Z Pipecut Manual portable is a straight forward hand operated compact chain - driven pipe cutting machine that provides a smooth, accurate cutting action by incorporating a low gear ratio and worm wheel drive.

\* Outside the USA the green hoses will be blue

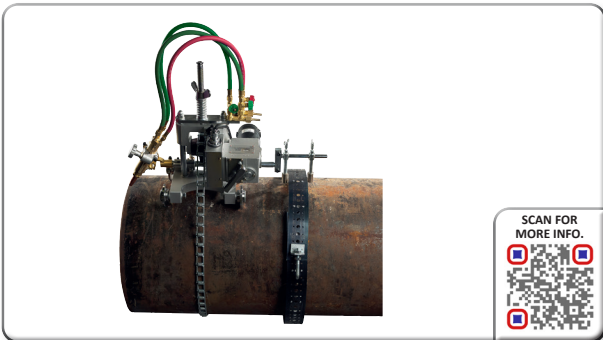

## MATHEY E-Z Pipecut Auto

**4" (114 mm) upwards**

The Mathey Dearman E-Z Pipecut Auto is the powered version of the E-Z Pipecut Manual. Once the speed is set correctly to the wall thickness of the pipe the machine can be driven around the pipe with a speed adjustable remote control. The E-Z Pipecut Auto will cut and bevel the pipe without the need for intervention from the operator. The E-Z Pipecut Auto portable oxy-fuel cutting machine can also be used for cutting exotic materials such as stainless steel, by converting from oxy-fuel to a plasma system (plasma torch holder available on request). Available in 110v or 220v power supply.

\* Outside the USA the green hoses will be blue

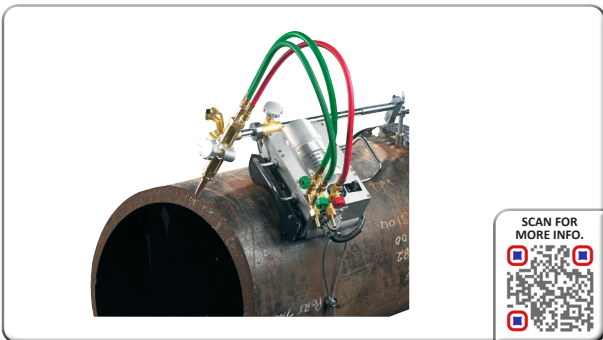

## MATHEY E-Z Pipecut Magnetic

**4" (114 mm) upwards**

The Mathey Dearman E-Z Pipecut Magnetic is the economical solution for cutting and beveling pipe from 350 mm upwards. The machine is small and compact, strong and reliable, used by contractors, welders and pipe fitters, equally on site as in the workshop. Two sets of magnetic, electrically driven roller wheels are housed inside the body of the machine. These rollers (offering a magnetic absorbability force of over 50 kg) ensure the machine stays in contact with the pipe as it travels around the circumference, cutting and beveling as it goes. Available in 110v or 220v power supply.

\* Outside the USA the green hoses will be blue

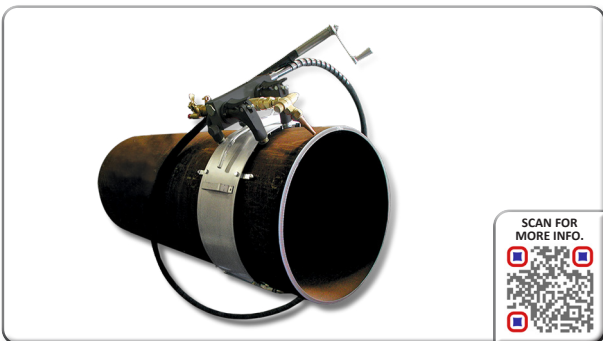

## MATHEY Band Crawler cutting and beveling machine

**6" - 60" (168.2 mm - 1,524 mm) o/d**

The ideal solution for cutting and beveling in close quarters, the Band Crawler requires as little as 6" (168.2 mm) of clearance around the pipe. Install the stainless steel band anywhere on the pipe and it conforms to the pipe shape, producing a consistent precise bevel, even on severely out-of-round pipe.

The lightweight Band Crawler can be quickly set up and operated by one person on pipe as large as 60" (1,524 mm). Bands 48" (1,219 mm) and larger feature a standard stiffening rib which simplifies one-person set-up.

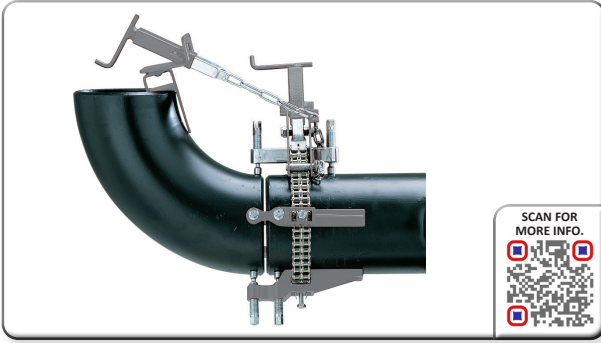

## MATHEY Sturdi pipe chain clamp

**1" - 72" (33.4 mm - 1,827 mm) o/d**

The Mathey Dearman Sturdi Clamp is a chain clamp ideal for schedule 40 and below pipe alignment and reforming.

One clamp can fit up a variety of sizes of pipes 1" to 36" (33.4 mm to 914 mm) diameter, elbows, tees, flanges end caps and most other pipe fittings (using the level and support device supplied).

The Mathey Dearman Sturdi Clamp is available in carbon steel chain or stainless steel version. All Mathey Dearman Sturdi Clamps feature stainless steel jackscrews, jackbars and main blocks.

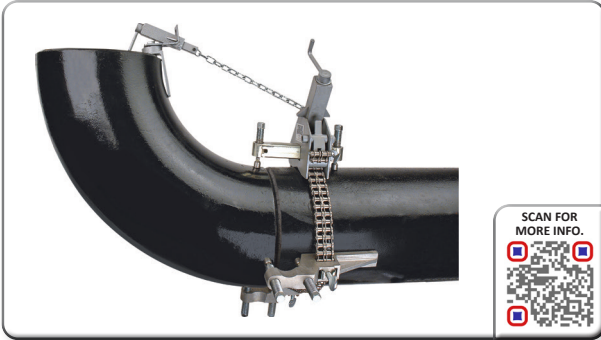

## MATHEY Double jackscrew chain clamp

**4" - 72" (114.3 mm - 1,827 mm) o/d**

Mathey Dearman invented the first chain clamp in 1930 and the Double Jackscrew chain clamp was launched in 1931.

The Double Jackscrew chain clamp reforms schedule 40 pipe on either side of the joint to be welded and it is also able to exert pressure on the high points of both sides to eliminate "Hi-Low". The chain clamp's level and support device allows the pipe, elbow, tee, flange and other fittings to be held securely in place during alignment and welding. Pipe with wall thicknesses up to schedule 80 can be aligned with the double jackscrew chain clamp.

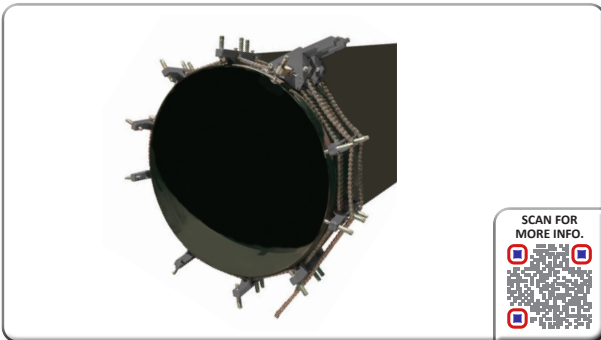

## E-Z Fit Double chain pipe clamp

**10" - 240" (273 mm - 6,100 mm) o/d**

The E-Z Fit Double chain pipe clamp is an extra heavy-duty clamp designed for alignment and reforming of pipes and vessels up to 20' (6M) with up to schedule 80 wall thickness. The double chain clamp will align pipes with any wall schedule.

Our specialised triple jackscrew heavy duty jackbars and double chain lock devices can deal with the most difficult of reforming jobs with operational ease. The extra heavy duty jackbars and double main block provide the strength to accomplish reforming jobs on pipe wall thicknesses that other clamps simply cannot.

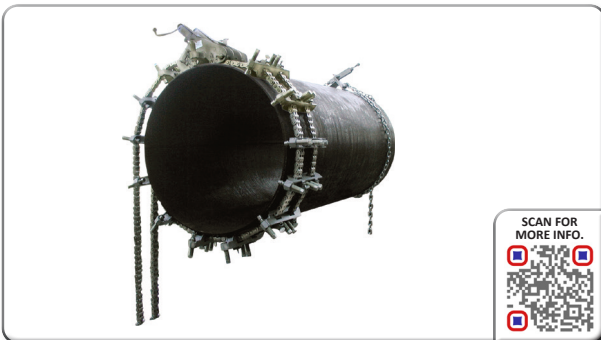

## MATHEY Double chain pipe clamp

**10" - 240" (273 mm - 6,100 mm) o/d**

Many process industries are seeing a resurgence in the need for double chain clamps in their pipefitting operations. In the oil and gas industry, for example, double chain clamping has more recently been used to align and reform steel pipe. When it comes to reforming and aligning the pipe, you can't get more heavy duty than Mathey Dearman's Double chain pipe clamps. The Mathey Dearman Double Chain clamp is an industrial-strength vessel clamp designed for alignment and reforming pipes and vessels up to 20' (6 m) in diameter with schedule 80 wall thickness.



## MATHEY Rim clamp

**4" - 60" (114.3 mm - 1,524 mm) o/d**

The Mathey Dearman Rim Clamp is built for tough reforming jobs and is ideal for applications requiring 100% weld and grind without releasing clamping pressure. Symmetrically placed jackscrews apply pressure on high points to precisely reform and align pipe or shells. All surfaces of the Rim Clamp in contact with the pipe are made of stainless steel enabling the clamp to be used on a variety of materials.

The Mathey Dearman Rim Clamp will reform 45,000 PSI tensile strength pipe up to schedule 80, with out-of-round conditions up to 2" (51 mm), depending on wall thickness.

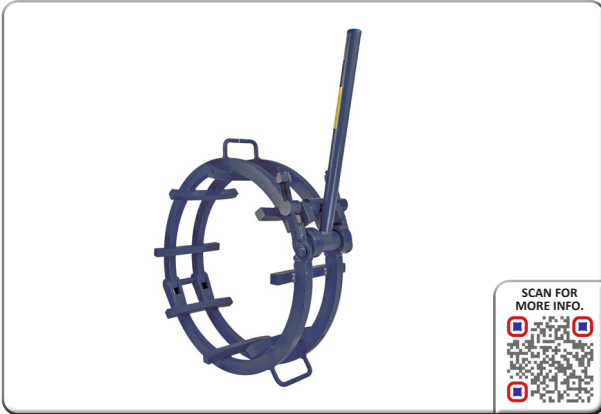

## MATHEY Lever cage clamp

**2" - 60" (60.3 mm - 1,524 mm)**

Mathey Dearman's cage clamp is available in manual hand lever, ratchet, and hydraulic models in either tack or no-tack versions, ranging in sizes for pipes 2" to 60" (60.3 mm to 1,524 mm). The cage clamps will align pipe through schedule 80.

Cage clamps are intended for alignment use only and are not designed to reform pipe.

Each size clamp fits one specific pipe diameter. If the O.D. of the pipe varies more than +/- 3/16" (5 mm) from the indicated clamp diameter, pipes may not align accurately.



## MATHEY Ratchet cage clamp

**6" - 60" (168.2 mm - 1,524 mm)**

The ratchet closure system of the Mathey Dearman Ratchet cage clamp provides the extra force needed to align large pipe diameters.

The Ratchet cage clamp is available for 14" to 60" (356 mm to 1,524 mm) pipe.



**Ratchet must be ordered separately**

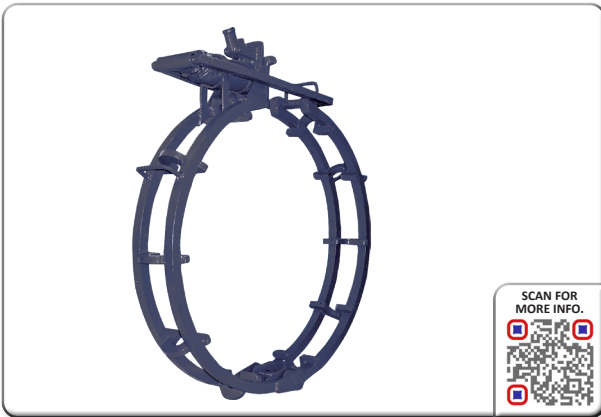

## MATHEY Hydraulic cage clamp

**6" - 60" (168.2 mm - 1,524 mm)**

Mathey Dearman's Hydraulic cage clamp utilizes a rugged hydraulic closure mechanism to create the extra force necessary to align large pipe diameters while also permitting the rapid release of the clamp from the pipe.

The Hydraulic cage clamp is available for 16" to 60" (406 mm to 1,524 mm) pipe.

**12 ton - Hydraulic jack included**



## MATHEY Super clamp

**6" - 36" (168.2 mm - 914 mm)**

- One clamp works on multiple pipe sizes
- Able to do light reforming to correct ovality in the pipe
- Able to push or pull the pipe joint together to attain the proper gap
- Works on carbon steels, stainless steels, and alloys
- Clamp can work on multiple types of joints
- Splitframe rim style clamp with turnbuckles, solid steel frames





# PIPE ALIGNMENT AND REFORMING CLAMPS



## MATHEY Sleeve clamp

**6" - 48" (168.2 mm - 1,219 mm)**

The Mathey Dearman Hydraulic Sleeve clamp is built to handle welded sleeves up to 3/4" thick and up to 70,000 PSI tensile strength.

Unlike the common and unsafe application of a bottle jack and chain, this purpose-built clamp provides virtually 360 degrees of clamping force for perfect fit-ups.

The easy to operate hydraulic closure system makes set up and removal easy and quick.

All models feature a 2-speed hydraulic hand pump for quicker installation and high-strength modular design for safer handling.

There are 4 models of clamps for any specific need and application - 5,000 PSI or 10,000 PSI of clamping pressure and 6" to 24" or 6" to 48" range for sleeves up to 3/4" (19 mm) thick.



# PIPE RIGGING EQUIPMENT



## MATHEY Slings and Cradles

Mathey Dearman's Pipe Cradles and Slings are an effective way to move pipe, specifically designed for pipeline installation projects.

- Durable 95a urethane coating designed for multiple uses
- Sealed anti-friction bearings
- Measures 4" tread width x 4.5" diameter
- 5/8" wire rope, swaged
- Machined hub for smooth wheel rotation

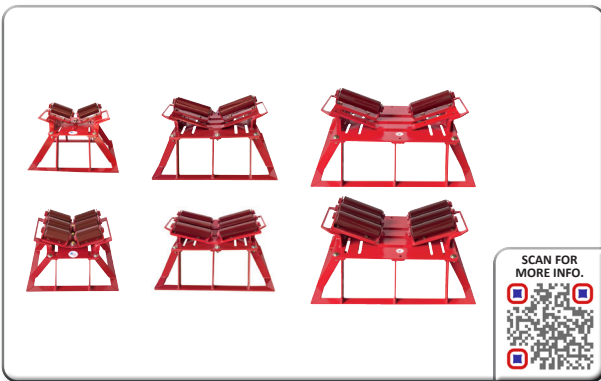

## MATHEY Pipe launchers

Mathey Dearman's Pipe Launchers have fully compatible parts that can change from a pipe rack clamping roller to a pipeline launcher in just a few minutes.

- Replaceable urethane roller wheels unbolt in seconds.
- Convenient and safe carry handles.
- Converts from pipe launcher to beam roller.
- Pipe Launchers nest and stack efficiently for shipping and storage.
- Easy part replacement with modular design.
- Add wheels to convert standard capacity to heavy-duty capacity.
- From 2" - 60" pipe capacity.
- Up to 20,000 lbs. weight capacity.



## MATHEY Beam clamp rollers

**2" - 60" (60.3 mm - 1,530 mm)**

Mathey Dearman's Beam Clamp Rollers are used for a variety of industries and applications, typically for installation of pipes into racks at Refineries, Power Stations and other Industrial Plants.

All the Mathey Dearman Beam Clamp Rollers are designed to be light weight, with I-beam clamps for quick installation and various roller head options so that all sizes and weights of pipe can be easily, safely and efficiently installed.





# Pipe & Industrial Tools™

## Introduction to B&B Pipe & Industrial Tools

The company B&B Pipe and Industrial Tools (B&B) was originally founded in Houston, Texas, USA in the 1990's, offering initially mainly the standard pipe rollers and applications, sold into petrochemical construction projects along the Texas Gulf Coast. Over the years B&B became an important player in the U.S. market.

With the merger in 2019 of B&B Pipe and Industrial Tools LLC (USA), Mathey Dearman Inc. (USA) and TAG Pipe Equipment Specialists (UK) and the recent addition in 2022 of AXXAIR (France) into Specialized Fabrication Equipment (S.F.E.) Group, the various product groups offered by the original manufacturers have been re-aligned and integrated into the overall S.F.E. Group product range whilst keeping their own brand identity.

Backed by nearly 30 years of development, today S.F.E. Group's B&B brand is dedicated to and covering pipe handling equipment, applications and solutions. With the B&B brand, S.F.E. Group not only wishes to highlight the focus on this particular product line, but also supply the growing demand and diverse applications in the industries that it already serves and intertwine with other product applications within S.F.E. Group.

As an OEM, S.F.E. Group prides itself being renowned for its innovations, ground-breaking developments and creative designs within the B&B product range. With its engineering capabilities, customer-oriented focus and flexibility, the B&B brand provides the possibility to design out-of-the-box pipe handling solutions to fulfil customers' projects' specific needs in particular and to cater for an ever-evolving industry in general.

The B&B brand portfolio consists of a comprehensive range of pipe purging equipment: **pipe jacks and stands**, **mega rollers and stands** and **material handling carts**.

B&B products are available from the international S.F.E. Group branches on 4 continents, as well as from S.F.E. Group's extensive and continuously expanding global network of partners and distributors.

**Get in touch for any pipe handling application.**

### PIPE JACK AND STANDS



B&B's pipe jacks and stands are an industry standard with many units sold into the field. The jacks and stands help the pipe fabricator hold the pipe at a safe and ergonomic elevation, allowing increased productivity. Made from quality steel tube and pipe, the jacks and stands offer great value, balancing the ability to withstand the everyday abuse of job site use while being available at a very competitive price.

### MEGA ROLLERS AND STANDS



B&B's mega rollers and jacks are a more robust, higher capacity line of material handling equipment than the standard line of jacks and stands. They allow increased pipe diameter capacity, as well as increased weight capacity. These mega rollers are built to last in the toughest of job site conditions.

### MATERIAL HANDLING EQUIPMENT



B&B's carts and buggies consist of job site material handling carts. The Stacker Cart can be shipped and stacked on the way to the job site minimising handling and shipping costs, then fold open for use while in the field. The pipe buggy models are designed to easily transport pipes, fittings and other parts on the job site or workshop, minimising ergonomic exposure and manual handling.



### B&B Fixed pipe jack (tri-stand)

**Pipe Size Capacity: 1" - 12" (Optional up to 24")**  
**Pipe Load Capacity: 1.5 Ton / 1,135 kg / 2,500 lbs.**  
**Height Adjustable: 71 cm - 122 cm / 27.5" - 48"**

The B&B Fixed pipe jack, constructed from box section for strength and safety, offers cost effective and safe solution to any pipe handling and support application or requirement.

The height adjustable pipe jack is available with a choice of slip-on, or interchangeable head styles for rotation or transferal movement.

The B&B Fixed pipe jack is individually available or in a crate of 30 pieces.



### B&B Folding pipe jack (tri-stand)

**Pipe Size Capacity: 1" - 12" (Optional up to 24")**  
**Pipe Load Capacity: 1.5 Ton / 1,135 kg / 2,500 lbs.**  
**Height Adjustable: 71 cm - 122 cm / 27.5" - 48"**

The B&B Folding pipe jack, constructed from box section for strength and safety, is designed with folding legs for easy storage and transportation. It offers cost effective and safe solution to any pipe handling and support application or requirement.

The height adjustable pipe jack is available with a choice of slip-on, or interchangeable head styles for rotation or transferal movement. The B&B Folding pipe jack is individually available or in a crate of 30 or 75 pieces.

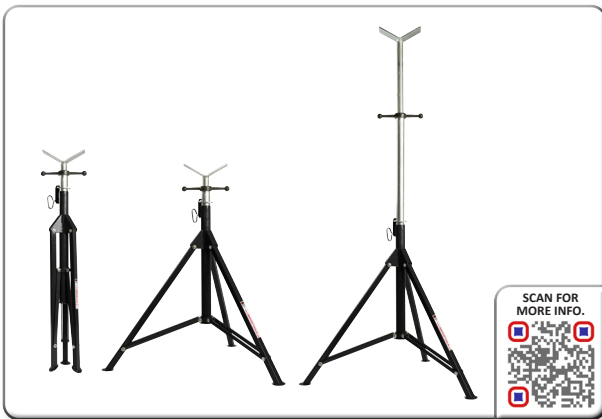

### B&B Six-foot folding pipe jack

**Pipe Size Capacity: 1" - 12"**  
**Pipe Load Capacity: 0.45 Ton / 450 kg / 1,000 lbs.**  
**Height Adjustable: 99 cm - 180 cm / 39" - 72"**

The B&B Six-foot folding pipe jack is ideal for pipe holding and leveling in high places. With a top height of 72" / 180 cm tall and a bottom adjustment of 39" / 99 cm, the Six-foot jack can be used for many applications.

The Six-foot jack is foldable and can be carried with ease, fitting into tight spaces when transporting. The height adjustment is performed with a locking tube and 1½" ACME adjustment.



### B&B Duo pipe stand

**Pipe Size Capacity: 2" - 48" / 51 mm - 1,219 mm**  
**Pipe Load Capacity: 2.4 Ton / 2,400 kg / 5,290 lbs.**  
**Height Adjustable: 74.5 cm - 108 cm / 29" - 42.5"**

The B&B Duo pipe stand accommodates pipes up to 48", is height adjustable and equipped with quick change style heads.

The Duo pipe stand has locking brakes on the wheels to secure the load for marking, layout or fit-up and is now supplied with folding legs as standard for ease of use and transport and has an ultra safe pin locking design.

The B&B Duo pipe stand is individually available or in a crate of 20 pieces.

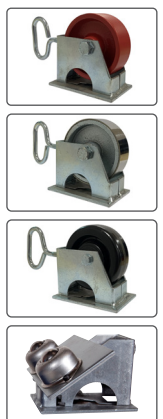



### B&B Adjustable Pipe Roller

**Pipe Size Capacity: 2" - 36"**  
**Pipe Load Capacity: 2,500 lbs.**

The B&B Adjustable Pipe Roller is used in pipe fabrication facilities and job-sites around the world.

The sturdy base and adjustable wheels are a favorite with medium size pipe fabrication projects allowing a stable work platform that allows pipe rotation.



### B&B Multi-roll Pipe Roller

**Pipe Size Capacity: 2" - 36"**  
**Pipe Load Capacity: 3,000 lbs.**

B&B introduces the new Multi-Roll Pipe Roller.

The new and improved Multi-Roll can raise and lower pipe to fit up under load and accommodate up to 36" pipe with no width adjustment necessary, thereby saving time and increasing safety. Available with steel, rubber and stainless steel wheels.

All wheels lock, restricting pipe rotation.



### B&B 3 leg giant jack

The B&B 3 Leg Giant Jack offers the same pipe diameter capacity of 36" and same capacity ratings as the 5 Leg Giant Jack, but is used in a static position.

The solid 1 1/4" ACME rod height adjustment sets the B&B Giant Jack apart from our competitor's hollow ACME-threads, along with increased leg tube dimensions.

Multiple wheel options including steel, stainless steel and rubber are ideal for a variety of applications.

B&B also offers stainless steel sleeves for fit-up involving exotic pipe that requires no rotation, ball transfer attachments that allow both rotation and feeding of rounds, or take the wheels off and you have oversized V-Head Pipe Jack ideal for heavy wall, large diameter steel pipe fit-ups.



### B&B 5 leg giant jack

**Pipe Size Capacity: 1" - 36"**  
**Pipe Load Capacity: 2.2 Ton / 2,265 kg / 5,000 lbs.**  
**Height Adjustable: 61 cm - 112 cm / 24" - 44"**

The B&B 5 leg giant jack is ideal for large diameter pipes (up to 36" / 920 mm) and its V-head can be equipped with multiple options. The 5 leg giant jack can be fitted with caster wheels, allowing pipe movement.

The 5 leg giant jack is characterised by its increased steel dimensions throughout, including 1 1/4" solid ACME rod, making it the toughest on the market.

The B&B 5 leg giant jack is individually available or in a crate of 11 pieces.



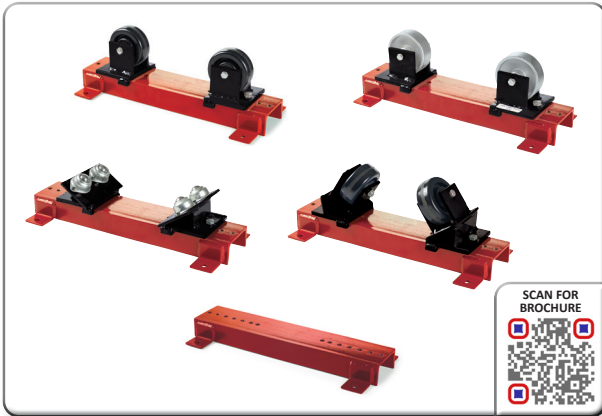

### B&B Roller stand (heavy duty)

**Pipe Size Capacity: 4" - 48" (100 mm - 1,220 mm)**  
**Pipe Load Capacity: 2.4 Ton / 2,400 kg / 5,290 lbs.**

These stands are designed to be either floor or bench mounted. Available with 4 head styles to suit pipe from 4" to 48" / 100 mm - 1,220 mm.

The floor/ bench stands can be used for pipe rotation, transferral movement, or both using the ball transfer head option. Nylon wheels are also available when working with stainless steel and other exotic materials to prevent contamination.

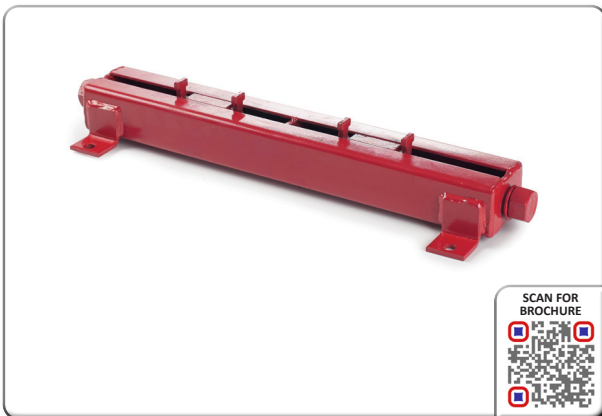

### B&B Quick change rollers

**2" - 28" (50 mm - 1,220 mm)**

This quick change roller stand is the top part of the popular duo pipe stand and is suitable to be floor or bench mounted.

Available with 2 adjustable head styles to suit pipes from 2" - 48" / 50 - 1,220 mm.

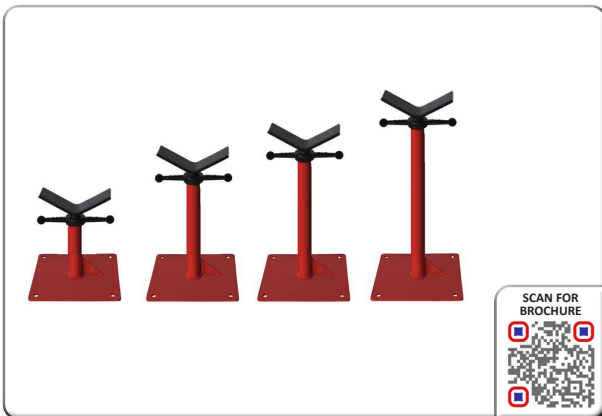
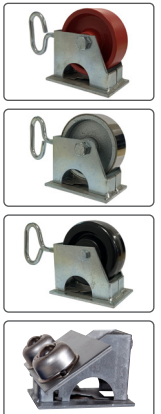

### B&B Uno pipe jack stand

**Pipe Size Capacity: up to 12"**

The UNO pipe jack stand is a basic single tubed pipe stand, simple to use and easy to set-up.

Popular for tight access jobs in power stations, submarines, refineries, etc.

A favourite for low level work in all fab shops.

Available in 4 standard heights.

Roller heads can also be fitted to the V-head of the UNO pipe jack stand to suit varying applications.



### B&B Tri-stand chain vice

**Pipe Size Capacity: up to 6"**

The B&B Tri-stand chain vice is a proven design used on construction sites around the globe. Durable cast aluminium head balances lightweight and durability.

Heavy duty hold down tightening device with replaceable jaw. Folding legs with chain lock. Leg bracing doubles as a lipped shelf for holding additional tooling and machines.

- Up to 6" pipe capacity
- Heavy duty jaws
- 55" width x 35" height (working dimensions)
- 1,000 lbs. / 450 kg capacity



## B&B Mega roller stand - 6,000 lbs. / 3 US ton

**Weight Capacity:** 6,000 lbs. / 2,721 kg  
**Pipe Capacity:** 4" - 48" / 10 cm - 121 cm  
**Working Height:** 31" - 48" / 86 cm - 122 cm

The B&B mega roller (6,000 lbs. / 2,721 kg) is a high capacity pipe roller designed for heavy duty job-site use.

Its oversized 6" x 3" wheels have an urethane over steel design, offering numerous advantages: they allow ultra smooth pipe rotation via heavy duty sealed bearings, for both steel, stainless steel and exotic alloys pipe. The unique head design also allows the removal of the wheels, transforming to a V-head stand restricting pipe rotation.

The robust construction, with its twin solid ACME rods, allows to raise and lower the headstock and wheels for precise fit-ups even under load.



## B&B Mega roller stand - 10,000 lbs. / 5 US ton

**Weight Capacity:** 10,000 lbs. / 4,535 kg  
**Pipe Capacity:** 6" - 60" / 10 cm - 152 cm  
**Working Height:** 25" - 35" / 63 cm - 88 cm

The B&B mega roller (10,000 lbs. / 4,535 kg) is a high capacity pipe roller designed for heavy duty job-site use.

Its oversized 10" x 3" wheels have an urethane over steel design, offering numerous advantages: they allow ultra smooth pipe rotation via heavy duty sealed bearings, for both steel, stainless steel and exotic alloys pipe. The unique head design also allows the removal of the wheels, transforming to a V-head stand restricting pipe rotation.

The robust construction, with its twin solid ACME rods, allows to raise and lower the headstock and wheels for precise fit-ups even under load.

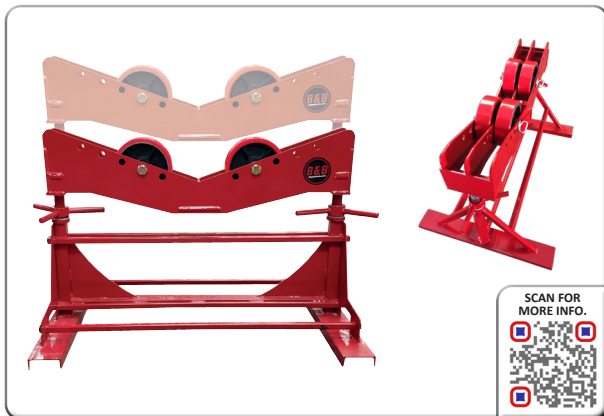

## B&B Mega roller stand - 15,000 lbs. / 7.5 US ton

**Weight Capacity:** 15,000 lbs. / 6,803 kg  
**Pipe Capacity:** 4" - 60" / 10 cm - 152 cm  
**Working Height:** 25" - 35" / 63 cm - 88 cm

The B&B mega roller (15,000 lbs. / 6,803 kg) is a high capacity pipe roller designed for heavy duty job-site use. This mega roller is built on the same platform as the 10,000 lbs. roller, but has an increased headstock width and two additional wheels added.

Its oversized 10" x 3" wheels have an urethane over steel design, offering numerous advantages: they allow ultra smooth pipe rotation via heavy duty sealed bearings, for both steel, stainless steel and exotic alloys pipe. The unique head design also allows the removal of the wheels, transforming to a V-head stand restricting pipe rotation.



## B&B Mega jack - 3 leg and 4 leg

B&B Mega Jacks are available with three or four legs with a wider and safer stance offering increased stability.

All Mega Jacks offer a large 16" V-head with reinforced V-gussets for added strength, increasing the weight capacity to 5,000 lbs.

Height adjustment is 1/4" solid ACME-thread and the elimination of the adjustment washer, inside tube and T-handle simplify use and reduce instances of potential operator error.



# MEGA ROLLERS AND STANDS

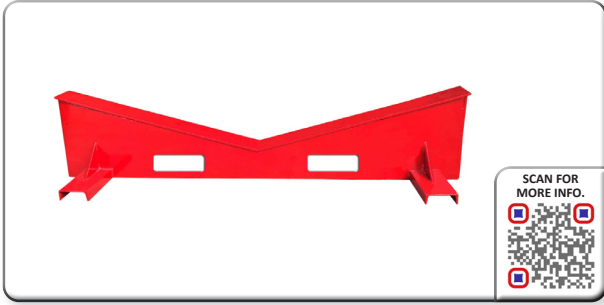

## B&B Mega block

The B&B Mega Block offers a safe and tested platform when setting and storing pipe. On many job-sites the pipe would either set directly on the ground, or be wedged between two pieces of wood to restrict rotation. The Mega Block accomplishes the same function, but in a safe, engineered and 3rd party tested product. Each Mega Block has fork lift slots and two lifting eyes for easy movement.



## B&B Mega horse

The B&B Mega Horse is a heavy duty pipe stand ideal for storing flats and rounds. This heavy duty pipe stand's robust construction allows years of use and abuse by professional pipeline fabricators in an engineered and tested design. Powder coating and clear capacity rated labeling makes this a long lasting and safe solid steel sawhorse for professional pipeline fabricators.



# MATERIAL HANDLING EQUIPMENT



## B&B Pipe cart

The B&B Pipe cart is a six wheeled, low height, narrow width cart that is strong enough to carry 2,000 lbs. / 910 kg, but agile enough to turn and fit through doorways with ease.

The push handles and V-block can be unassembled and stored in seconds when not in use.

If you remove the V-block attachment from the cart you have a 2,000 lbs. / 910 kg cart capable of moving just about anything within rated capacity.



## B&B Bundle cart

The B&B Bundle Cart is similar to the B&B Pipe Cart, but is designed for the storage and transport of multiple smaller diameter pipe, tube, and/or conduit. The fold down brackets can rest in a lowered position allowing storage, stacking and transport efficiency. Robust 2" square heavy gauge tubing and oversized 6" caster make the B&B bundle cart a great addition to many job-sites across multiple trades.



## B&B Crate cart

The B&B Crate Cart is a nice addition to the B&B cart line and works on the same modular platform. This simple, yet effective, four sided cart is a great storage and transport cart that handles a 1,500 lbs. weight capacity and yet still fits through a 36" door frame common on job-sites. Two fixed and two swivel 6" steel wheels are standard and shipped assembled.





### B&B Conduit carts

B&B Conduit Carts are not only for conduit. Any rounds that need to be stacked or separated fit into the 8 holding sections, and with four heavy-duty wheels the carts allow easy movement around the job-site. The gravity lock hinge mechanism adds an increased safety feature by eliminating an instance of user error, and the stacking cups mean efficient storage and transport when the carts are not in use. All carts are modular in construction and stack and store with one another.



### B&B Stake cart

Our new and improved Stacker Carts are now on the market. We took all the good things that our carts offered, then added a few more features that make our carts stand apart!



### B&B Hanger carts

New in the B&B Stacker Cart Line is the Hanger Cart. The B&B Hanger Cart is a modular design that stacks and folds for efficient shipping and storage, just like all B&B Stacker Carts. These carts can be loaded with various clevises and pushed into the installation location with ease. Once the job is complete or the carts are no longer needed, fold them, stack them, and ship or store them.



### B&B Baby pipe buggy

The B&B Baby pipe buggy is designed to help move pipe, fittings and other items with ease.

Great for use in construction projects around the world, the B&B Baby pipe buggy ships in a cardboard box with 5 minute assembly of wheels and handle.

16" tires can move up to 1,000 lbs. / 453 kg payload and up to 12" diameter pipe.

The B&B Baby pipe buggy is shipped with a hold down strap.



### B&B Biggy pipe buggy

The B&B Biggy pipe buggy allows one man to move up to 24 foot / 732 cm long pipe and up to 2,000 lbs. / 907 kg of weight unassisted. The B&B Biggy pipe buggy ships unassembled in a wooden crate for ease of shipment and can be assembled in less than 15 minutes.



### B&B Cylinder / Bottle carts

Two sizes available: BCM Series: holds a 9 1/4" tank and a 8 1/2" tank  
BCL Series: holds a 13" tank and a 9 1/4" tank

Four wheel options: 8-inch rubber over steel rim  
14-inch rubber over steel rim  
16-inch air filled tires  
16-inch flat free tires







## PIPE EQUIPMENT SPECIALISTS

# Introduction to TAG Pipe Equipment Specialists

The company TAG Pipe Equipment Specialists LTD (TAG PIPE) was originally founded in the United Kingdom in 1985. Its core activities were the manufacturing and supplying of pipework fabrication tools and machinery, as well as handling equipment. Over the years TAG PIPE became internationally one of the foremost leaders in its field.

**S.F.E. Group's TAG PIPE range of cold cutting and bevelling machines is established and recognised as one of the world's leading and prominent brands.**

Being one of the driving factors of the organization's success, TAG PIPE's range of pipe cutting and bevelling machines warranted becoming its own brand in 2019 following the merger in 2019 of B&B Pipe and Industrial Tools LLC (USA), Mathey Dearman Inc. (USA) and TAG Pipe Equipment Specialists (UK) and the recent addition in 2022 of AXXAIR (France) into Specialized Fabrication Equipment (S.F.E.) Group.

Backed by more than 35 years of development, S.F.E. Group's brand TAG PIPE not only ensures the highest quality heavy duty machines utilising the latest technology, but also an emphasis on continuous R&D.

As an OEM, S.F.E. Group prides itself being renowned for its innovations, ground-breaking developments and patented designs within the TAG PIPE range. With its engineering capabilities, customer-oriented focus and flexibility, the TAG PIPE brand provides the possibility to design out-of-the-box machining applications and solutions to fulfil customers' projects' specific needs in particular and to cater for an ever-evolving industry in general.

The TAG PIPE brand portfolio consists of a complete range of portable pipe bevel machines (**PREP machines** covering 1" - 24"), the TAG PIPE cutting and bevelling **splitframe clamshell machines** (1" - 120"), as well as the stationary, yet moveable **EZ FAB machines** (2" - 16") for pipe cutting and bevelling, the EZ pipe saws and finally the **PMM plate bevel machines**.

TAG PIPE's products are available from the international S.F.E. Group branches on 4 continents, as well as from S.F.E. Group's extensive and continuously expanding global network of partners and distributors.

**Please do not hesitate to contact us for any pipe cutting and bevelling application.**

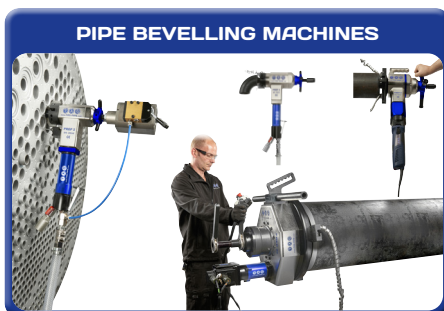

TAG manufactures a large range of i/d locking portable end PREP machines ranging from ½" to 42". TAG bevelling machines can produce all types of weld preparations required on any kind of metals from standard carbon steel to tough material such as super duplex and inconel.



TAG also manufactures a diverse range of small, medium and large diameter pipe cutting and bevelling machines for both workshop and job site applications covering from 1" to 120" pipe.

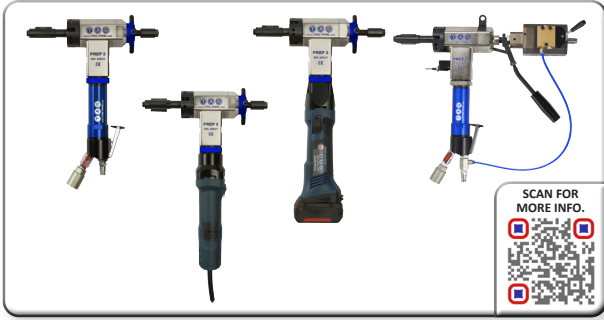

### TAG Pipe beveling machine PREP 2

**½" - 1½" (23 mm - 42 mm i/d) (optional 12.5 mm)**

**Power: Pneumatic, electric or battery (110v or 220v)**

The smallest in our range of i/d locking, direct in-line feed end prep machines. The PREP 2 is small, light weight, yet powerful.

Simultaneous external and internal beveling and facing of pipe or tubes is simple, ideal for accurate repetitive work. Its size, power and functionality, make it extremely popular in high volume heat exchanger work, tube facing, weld removal and J-prepping of the tube plate.

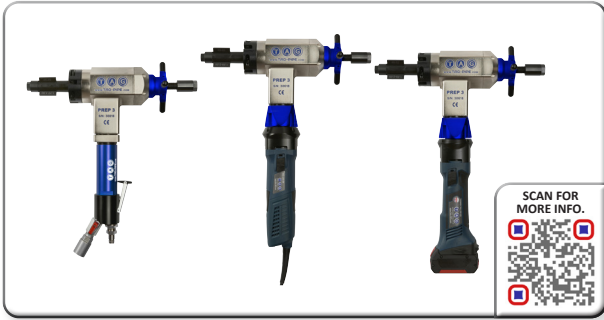

### TAG Pipe beveling machine PREP 3

**1" - 3" (28 mm - 76 mm i/d) (optional 20 mm)**

**Power: Pneumatic, electric or battery (110v or 220v)**

The PREP 3 is one of our most popular i/d locking, in-line feed end prep machines. The PREP 3's power to weight ratio is unrivalled.

Simultaneous external and internal beveling and facing of tubes can be performed with ease for accurate repetitive work. Its size, power and functionality, makes it extremely popular in high volume boiler repair and maintenance work, tube facing, weld removal, and J-prepping of the tube plate.

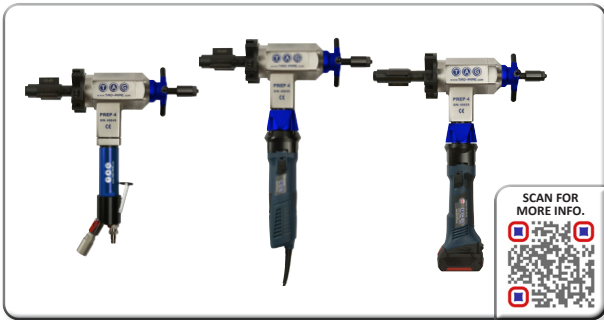

### TAG Pipe beveling machine PREP 4

**1" - 4" (23 mm - 112 mm i/d)**

**Power: Pneumatic, electric or battery (110v or 220v)**

The PREP 4 is a very popular versatile machine that is robust and extremely powerful. Used in many industries but commonly found in tough in-situ environments, such as power station shut downs.

The PREP 4 boasts an increased locking range of 1" to 4" i/d.

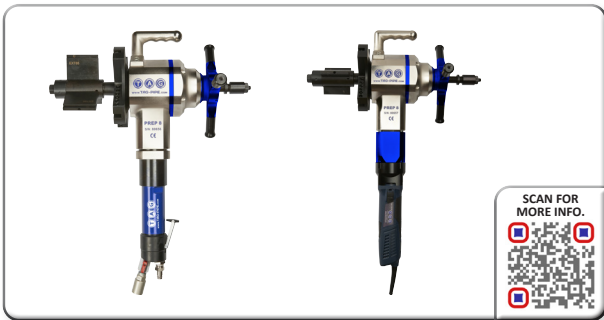

### TAG Pipe beveling machine PREP 8

**2" - 8" (50 mm - 207 mm i/d)**

**Power: Pneumatic, electric (110v or 220v)**

One of our most powerful and popular small diameter i/d locking, in-line feed end prep machines. This is mainly due to its impressive 2" to 8" working range and unrivalled power. The PREP 8 is a portable, one man operation machine, its power to weight ratio, and offset 4 jaw tool holder (chuck) allows use of up to 4 insert or form tools to enable simultaneous external, internal beveling of even the heaviest wall pipe and tube, on site, or in the fabshop.

## OPTIONS:



**Battery Motor**



**Ratchet Handles**

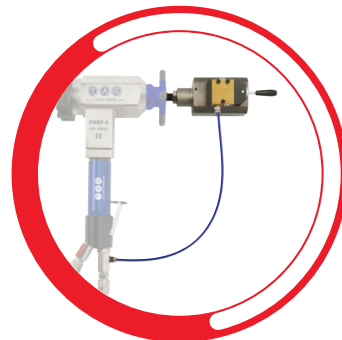

**Auto Locking**



**Elbow Shafts**



# PIPE BEVELLING MACHINES



## TAG Pipe beveling machine PREP 16

**3" - 16" (72 mm - 385 mm i/d)**

**Power: Servo electric (recommended), pneumatic or hydraulic**

The PREP 16 is the first in TAG's new range of a heavy duty mid-large diameter beveling machines. Offering ratcheted i/d jaw locking as well as ratchet bevel feed control for effortless heavy wall preps, offered with an extremely powerful and user friendly servo electric or pneumatic motor. Any bevel geometry can be performed within the impressive 3" - 16" range.

J-preps, counter boring, and facing can all be performed, simultaneously, using the correct tooling fitted in (up to) 4 heavy duty hardened multi-position tool holders. Due to its light weight, yet unrivalled power, the PREP 16 is ideal for on-site, off shore, nuclear, and other applications where precision welds are required at an incredible value.



## TAG Pipe beveling machine PREP 24

**7" - 24" (180 mm - 600 mm i/d)**

**Power: Servo electric (recommended), pneumatic or hydraulic**

The PREP 24 is the largest in TAG's new range of a heavy duty mid-large diameter beveling machines. Offering ratcheted i/d jaw locking as well as ratchet bevel feed control for effortless heavy wall preps, offered with an extremely powerful user friendly servo electric or pneumatic motor. Any bevel geometry can be performed within the impressive 7" - 24" range.

J-preps, counter boring, and facing can all be performed, simultaneously, using the correct tooling fitted in (up to) 4 heavy duty hardened multi-position tool holders. Due to its light weight, yet unrivalled power, the PREP 24 is ideal for on-site, off shore, nuclear, and other applications where precision welds are required at an incredible value.



## PREP 16 AND 24 ELBOW FITTING MACHINES:

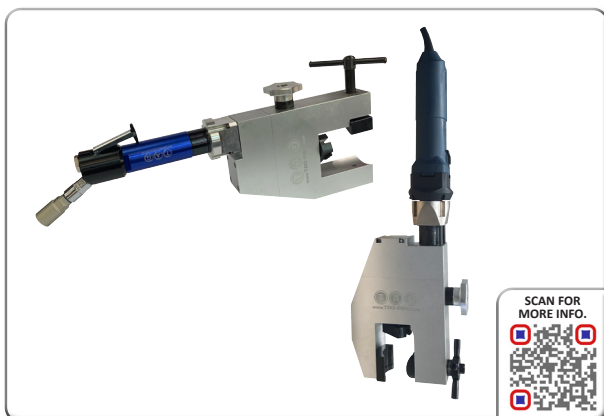
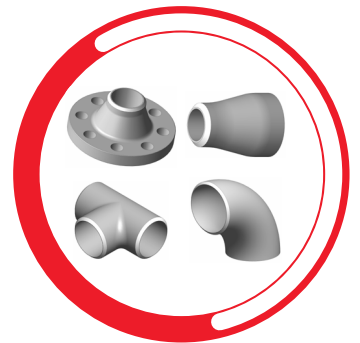
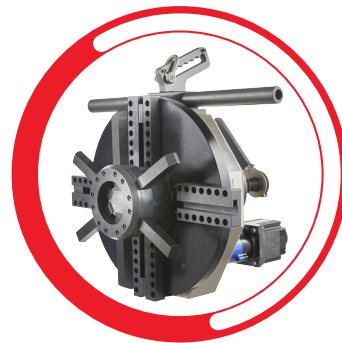

## TAG Panel prep machines

**RANGE: 8 - 108 mm (0.5 - 4")**

**Power: Pneumatic, electric (110v or 220v)**

The TAG PANEL PREP attaches to the tube outside diameter by means of custom or specific o/d clamp type jaws that provide strong clamping action that minimizes chatter and vibration.

It is designed for maximum comfort, efficiency, safety, and ease of use. The feed wheel handle enables the operator to comfortably feed the tool during beveling or facing. The TAG PANEL PREP is suitable for small bore heavy wall tubes with a high percentage of chrome, stainless steel, and other exotic alloys.

The machine can be used for standard beveling applications and for opposite tubes.





## TAG Split frame clamshells cold cutting and bevelling machines

**1" - 48" (25 mm - 1,220 mm)**

The TAG Split Frame Clamshell range of portable cold pipe cutting and bevelling machines are designed for ease of use, even in difficult situations. Thanks to their low profile frame they are the perfect machines for use when access to the pipe is restricted.

The TAG range of Cut and Prep Split Frame Clamshells are available with pneumatic, servo electric motors and hydraulic motors, and will cover a range from 1" to 54" o/d (6" range per ring). Larger sizes are available on request. Cutting and bevelling can be performed simultaneously; any type of weld prep can be achieved including compound angles and "J-preps".

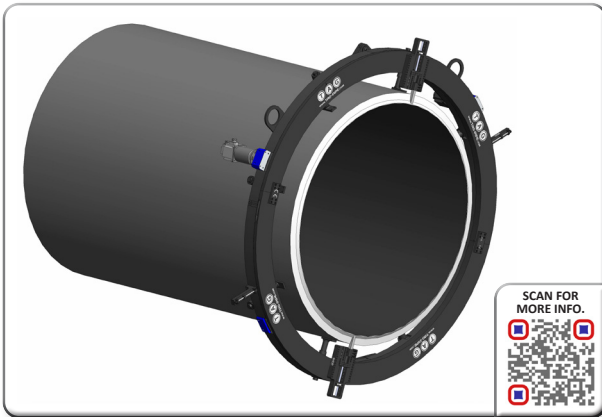

## TAG Split frame clamshells cold cutting and bevelling machines

**48" - 120" (1,220 mm - 3,050 mm)**

TAG also manufactures heavier duty steel construction split frame cutting and bevelling machines. Rugged in design, and built to stand up to the most arduous of site conditions.

Available in pneumatic, electric and hydraulic power supplies, the TAG heavy duty Clamshell Cut and Prep machines can cut and bevel pipes of almost any wall thickness and any material.



## TAG E-Z FAB pipe cutting and bevelling machine

**2" - 16" (60 mm - 420 mm)**

**Power: Servo electric 110v / 220v**

The E-Z FAB is a revolutionary new cutting and bevelling system for pipes. Ideally suited, but not limited to workshops, and high productivity process environments.

The E-Z FAB utilises a similar principle to the clamshell split frame cutting and bevelling machines. The E-Z FAB consists of a movable trolley fitted with a case outer body housing the rotating, working cutting ring which is driven by an NC controlled powerful 1.5kw servo electric motor. This design provides strength, rigidity and speed as well as high efficiency and precision to the pipe cutting process.

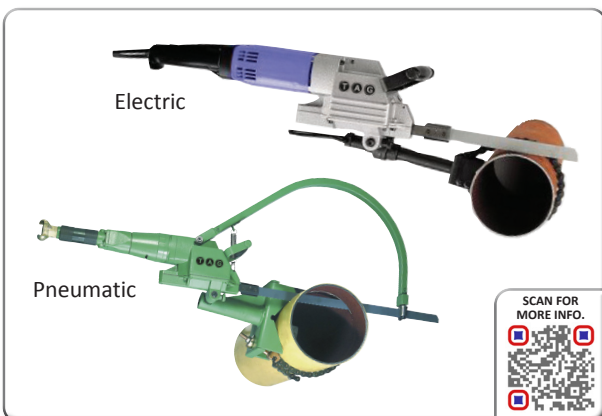

## TAG E-Z pipe saw

**1" - 12" o/d (optional up to 24")**

**Power: Pneumatic, electric (110v or 220v)**

A powerful reciprocating saw, ideal for use on site.

The light weight construction and ease of set up makes the E-Z Pipe Saw ideal for site work applications. By using the pipe locking vice or chain locking device the E-Z Pipe Saw produces square cuts. The E-Z Pipe Saw is also capable of mitre cutting angles of up to 45° on up to 4" pipe. Using the correct blades most materials can be cut including stainless steel and duplex.

The E-Z Pipe Saw is available in pneumatic and electric.





## TAG PMM155 handheld plate beveller

**From 1.5 mm plate thickness**

TAG's range of handheld beveling machines are the most durable and versatile on the market. The range is capable of beveling and radiusing straight edges, shapes, contours and holes from 20° to 60°.

Using tungsten carbide inserts the machines can bevel from 1.5mm up to 40mm on Aluminium plate and an impressive 16mm on Carbon and Stainless Steel!!

These units can also be used for dressing and de-burring, and is available with a range of radius heads and inserts. Available in electric 110v or 220v power supply.



## TAG PMM200 handheld plate beveller

**Plate thickness 6 mm - 60 mm (21 mm max bevel width)**

The PMM200 is a new generation, easy to use, portable, heavy duty machine designed for beveling steel plates prior to welding. This beveling machine is fitted with two milling heads each holding six inserts, allowing smooth operation and exceptional efficiency, capable of angles from 0° to 60°.

The PMM200 incorporates many safety features. It has a state of the art electronic control module protecting the operator, machine and tools. It is equipped with guide rolls, which make it easy and light to operate.

TAG have now released the PMM200SS Model, this model is dedicated to the beveling of stainless steels, and other harder materials.



## TAG PMM200SS handheld plate beveller

**Plate thickness 6 mm - 60 mm (21 mm max bevel width)**

The PMM200 is a new generation, easy to use, portable, heavy duty machine designed for beveling steel plates prior to welding. This beveling machine is fitted with two milling heads each holding six inserts, allowing smooth operation and exceptional efficiency, capable of angles from 0° to 60°.

The PMM200 incorporates many safety features. It has a state of the art electronic control module protecting the operator, machine and tools. It is equipped with guide rolls, which make it easy and light to operate.

TAG have now released the PMM200SS Model, this model is dedicated to the beveling of stainless steels, and other harder materials.



# AXXAIR

## Introduction to AXXAIR

With the merger in 2019 of B&B Pipe and Industrial Tools LLC (USA), Mathey Dearman Inc. (USA) and TAG Pipe Equipment Specialists (UK) and the recent addition in 2022 of AXXAIR (France) into Specialized Fabrication Equipment (S.F.E.) Group, the various product groups offered by the original manufacturers have been re-aligned and integrated into the overall S.F.E. Group product range whilst keeping their own brand identity.

Originally founded in 1997, the brand AXXAIR encompasses within S.F.E. Group the overall tube working processes: orbital cutting, tube bevelling, squaring and orbital welding. The AXXAIR brand has been in the global market for over 25 years and has established itself as a leading and international reference on the field of tube processing applications.

AXXAIR offers innovative solutions to improve processes, productivity, efficiency and quality in the field of orbital cutting, bevelling and welding on a wide variety of different materials such as stainless steel, titanium, carbon steel, duplex and super duplex stainless steel, nickel alloys and even plastic. Within the AXXAIR range S.F.E. Group not only offers a standard range of products, but also customized solutions for specific target markets: the food and beverage industry, pharmaceuticals, the manufacturing of semi-conductors, aeronautics, chemical and petrochemical industry as well as the nuclear industry and many other possible areas of application.

The S.F.E. Group AXXAIR brand portfolio consists of a complete range of **cutting machines** (covering 0.25" - 40"), **squaring machines** (0.1" - 8.5"), as well as welding machines: **SATO open heads** (0.4" - 8.265"), **SATFX closed heads** (0.25" - 4.5"), **Microfit SXMF** (1/8" - 5/8") and finally the **SATP tube to tube sheet** (0.4" - 3").

Get in touch for any orbital cutting, squaring and welding application.



### ORBITAL CUTTING AND FACING



AXXAIR's orbital cutting machines feature stainless steel concentric jaws to prevent the deformation of the tubes, especially the one with thin walls, during clamping. AXXAIR's frames are easily scalable for bevelling and welding application. The AXXAIR facing machines operate on battery or corded for more flexibility. The TIALN blades, reversible with two cutting edges, guarantee optimal lifetime of consumables. The facing machines are lightweight and designed to be used on site as well as in the workshop.

### ORBITAL WELDING



AXXAIR's new range of closed SATFX welding heads allows to achieve high quality welds in a minimal space. The range of open welding heads (SATO series) are mainly recommended for the agro-food, pharmaceutical, chemical sectors, for wall thicknesses less than but also greater than 3 mm. The Micro-Fitting Series have been designed to weld small diameters tubing and fittings mainly in the semiconductor industry. AXXAIR offers a range of different welding power supplies fulfilling the varying needs depending on the customer's intended use, tube sizes, welding application and frequency of utilisation.



### AXXAIR Orbital cutting (eco range)

**0.25" - 6.625" (5 mm - 170 mm)**

- Accessible and efficient orbital cutting machine.
- High-precision cutting without tube deformation.
- Ideal for cutting thin walled tubes.

Three models are available in the range, AXXAIR orbital cutting (eco range):

- CC81M : 0.25" - 3" (5 mm - 78 mm)
- CC121ECO : 0.25" - 4.5" (5mm - 121 mm)
- CC171ECO : 0.625" - 6.625" (16 mm - 170 mm)

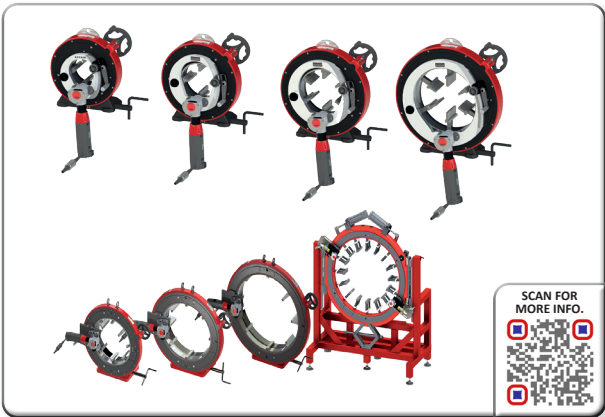

### AXXAIR Orbital cutting

**0.25" - 40" (5 mm - 328 mm)**

Robust and powerful orbital cutting machine, high-precision cutting without tube deformation. Evolutive machine : can be transformed into an orbital bevelling and welding machine.

Eight models are available in the range, AXXAIR orbital cutting:

- CC122\* : 0.25" - 4.5" (5 mm - 119 mm)
- CC172\* : 0.625" - 6.625" (16 mm - 173 mm)
- CC222\* : 2.375" - 8.625" (55 mm - 228 mm)
- CC322\* : 5.563" - 12.750" (141 mm - 328 mm)
- CC421 : 8.625" - 16" (212 mm - 422 mm)
- CC521 : 12.75" - 20" (312 mm - 522 mm)
- CC721 : 18" - 28" (447 mm - 725 mm)
- CC1100 : 28" - 40" (711 mm - 1016 mm)



### AXXAIR Tube squaring

**0.1" - 8.5" (3 mm - 220 mm)**

Tube squaring consists in bringing the end of a tube or an accessory into conformity and acts on 3 aspects: the perpendicularity of the tube face (maintenance) - the surface state of the face - a length adjustment. Burfree facing, the chip unrolls towards the outside of the tube. Perfect preparation for thin tubes before orbital welding.

Eight models are available in the range, AXXAIR tube squaring:

- DC25 : 0.1" - 1" (3 mm - 25.4 mm)
- DC65 : 0.1" - 2.5" (3 mm - 63.5 mm)
- DC115 : 0.5" - 4.5" (12 mm - 115 mm)
- DC221 : 2" - 8.5" (50 mm - 220 mm)



### AXXAIR Orbital welding: power source

TIG orbital power supplies has been designed to be user-friendly and intuitive to easily generate programs.

Intuitive touch screen interface and automatic parameter calculation mode integrated into the generator. Program classification system by welding configuration.

Two separate gas lines, free choice of inerting gas flow management. Compatible with some closed heads of the following brands : AMI, Polysoude, ESAB, Orbitec and Orbitalum.

Many accessories available: trolley, Wire dispenser, hand torch, PPM reader, switchbox...

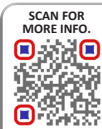



### AXXAIR Orbital welding: prefabrication

**0.25" - 12.750" (12 mm - 328 mm)**

Machines for orbital prefab welding : robust and easy to use. It enables production of medium to large series of welding sub-assemblies.

Easy to use : Intuitive interface and parameters adapted to the characteristics of the tubes integrated into the SAXX power sources range.

Evolutive machine : can be transformed into an orbital cutting and bevelling machine.

Four models are available in the range, AXXAIR orbital prefabrication:

**SX122** : 0.25" - 4.5" (12 mm - 119 mm)

**SX222** : 2.375" - 8.625" (55 mm - 228 mm)

**SX172** : 0.625" - 6.625" (16 mm - 173 mm)

**SX322** : 5.563" - 12.750" (141 mm - 328 mm)

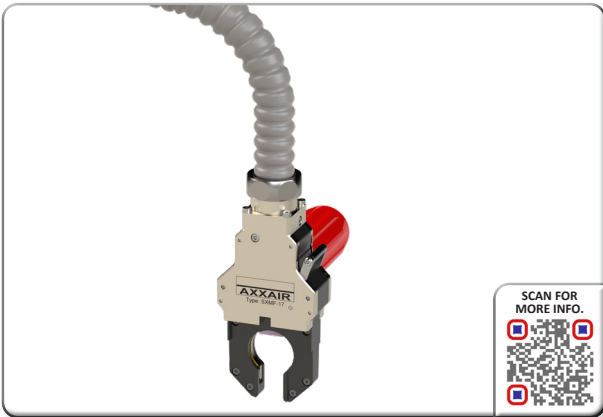

### AXXAIR Orbital welding: microfit heads

**1/8" - 5/8" (3 mm - 17.2 mm)**

Microfit closed head with cassettes for orbital welding.

Optimum tube and fittings positioning while controlling the tightening forces so as not to distort or mark your tubes.

Optimum gas protection due to closed chamber: welds with very limited staining.

Easy to use: Intuitive interface and parameters adapted to the characteristics of the tubes integrated into the SAXX power sources range.



### AXXAIR Orbital welding: closed heads

**0.25" - 4.5" (6 mm - 115 mm)**

New range of orbital closed welding heads to meet the most demanding welding requirements in the most confined spaces. Grease-free operation: compatible with clean room standards. Perfect gas protection in the welding head thanks to the closed chamber: welding with very limited coloration. Easy to use: Intuitive interface and parameters adapted to the characteristics of the tubes. Software integrated into the SAXX power sources range.

Three models are available in the range, AXXAIR orbital welding closed heads:

**SATFX-52** : 0.25" - 2" (6 mm - 52 mm)

**SATFX-115** : 0.5" - 4.5" (12 mm - 115 mm)

**SATFX-76** : 0.25" - 3" (6 mm - 77 mm)

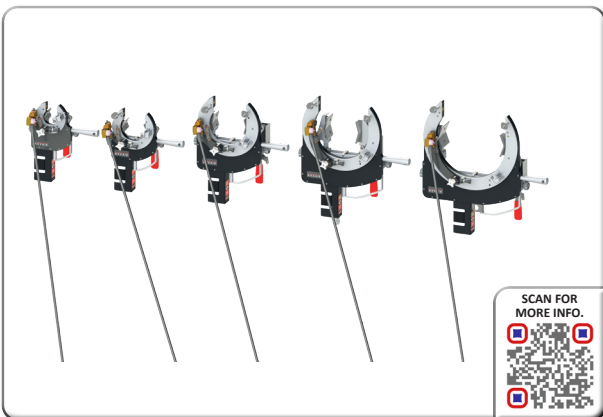

### AXXAIR Orbital welding: open heads

**0.4" - 8.265" (10 mm - 220 mm)**

Open welding head with symmetrical clamping system, offering a very wide range of use to make very high quality welds in a minimum space. Easy to use: Intuitive interface and parameters adapted to the characteristics of the tubes integrated into the SAXX power sources range. Quality and repeatability of welds to ensure high productivity.

Five models are available in the range, AXXAIR orbital welding open heads:

**SATO-40** : 0.4" - 1.5" (10 mm - 40 mm)

**SATO-170** : 1" - 6.625" (25 mm - 170 mm)

**SATO-80** : 0.75" - 3" (19 mm - 80 mm)

**SATO-220** : 1.5" - 8.265" (38 mm - 220 mm)

**SATO-115** : 0.75" - 4.5" (19 mm - 115 mm)



## PRODUCT UNDER < 3MM



### AXXAIR Orbital welding: tube to tubesheet

**0.4" - 3" (10 mm - 80 mm)**

Orbital welding head for tube to tube sheet applications in heat exchanger productions. Portable and easy to move machine with integrated wire dispenser. Can be used directly on worksite.

Intuitive interface and automatic parameter calculation mode integrated into the SAXX power sources range.

Quality and repeatability of welds to ensure high productivity.

## PRODUCT OVER > 3MM

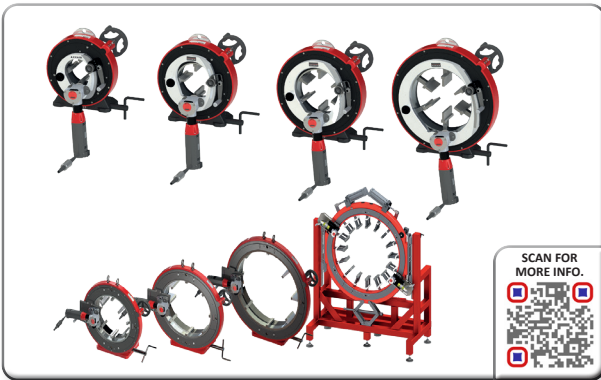

### AXXAIR Orbital cutting

**0.25" - 40" (5 mm - 1016 mm)**

Robust and powerful orbital cutting machine, high-precision cutting without tube deformation. Evolutive machine: can be transformed into an orbital bevelling and welding machine.

Eight models are available in the range, AXXAIR orbital cutting:

CC122* : 0.25" - 4.5" (5 mm - 119 mm)	CC421 : 8.625" - 16" (212 mm - 422 mm)
CC172* : 0.625" - 6.625" (16 mm - 173 mm)	CC521 : 12.75" - 20" (312 mm - 522 mm)
CC222* : 2.375" - 8.625" (55 mm - 228 mm)	CC721 : 18" - 28" (447 mm - 725 mm)
CC322* : 5.563" - 12.750" (141 mm - 328 mm)	CC1100 : 28" - 40" (711 mm - 1016 mm)

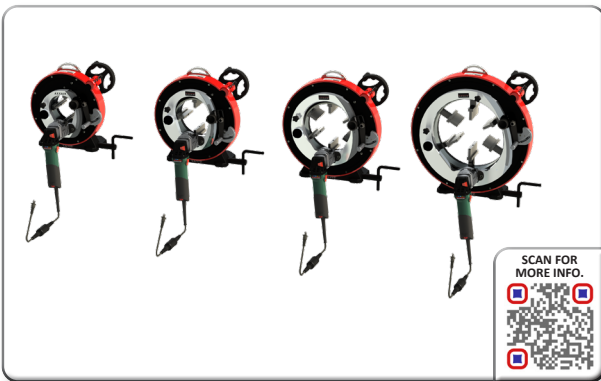

### AXXAIR Orbital bevelling

**5.8" - 12.75" (15 mm - 328 mm)**

Orbital bevelling machine : portable machine, easy to move and can be used both on site or in a workshop. Simple and quick adjustment of the height of the bevel.

Perfect preparation for thick tubes before welding with filler wire.

Evolutive machine : can be transformed into an orbital cutting and welding machine.

Four models are available in the range, AXXAIR orbital bevelling:

GA122 : 5.8" - 4.5" (15 mm - 119 mm)	GA222 : 2.35" - 8.625" (55 mm - 228 mm)
GA172 : 1.3" - 6.625" (33 mm - 173 mm)	GA322 : 5.5" - 12.75" (141 mm - 328 mm)



### AXXAIR Orbital welding: power source

TIG orbital power supplies has been designed to be user-friendly and intuitive to easily generate programs.

Intuitive touch screen interface and automatic parameter calculation mode integrated into the generator. Program classification system by welding configuration.

2 separate gas lines, free choice of inerting gas flow management.

Compatible with some closed heads of the following brands : AMI, Polysoude, ESAB, Orbitec et Orbitalum.

Many accessories available: trolley, Wire dispenser, hand torch, PPM reader, switchbox...



### AXXAIR Orbital welding: prefabrication

**0.25" - 12.750" (12 mm - 328 mm)**

Machines for orbital prefab welding : robust and easy to use. It enables production of medium to large series of welding sub-assemblies.

Easy to use : Intuitive interface and parameters adapted to the characteristics of the tubes integrated into the SAXX power sources range.

Evolutive machine : can be transformed into an orbital cutting and bevelling machine.

Four models are available in the range, AXXAIR orbital cutting:

**SX122** : 0.25" - 4.5" (12 mm - 119 mm)

**SX222** : 2.375" - 8.625" (55 mm - 228 mm)

**SX172** : 0.625" - 6.625" (16 mm - 173 mm)

**SX322** : 5.563" - 12.750" (141 mm - 328 mm)



### AXXAIR Orbital welding: open heads

**0.4" - 8.265" (10 mm - 220 mm)**

Open welding head with symmetrical clamping system, offering a very wide range of use to make very high quality welds in a minimum space. Easy to use: Intuitive interface and parameters adapted to the characteristics of the tubes integrated into the SAXX power sources range. Quality and repeatability of welds to ensure high productivity.

Five models are available in the range, AXXAIR orbital welding open heads:

**SATO-40** : 0.4" - 1.5" (10 mm - 40 mm)

**SATO-170** : 1" - 6.625" (25 mm - 170 mm)

**SATO-80** : 0.75" - 3" (19 mm - 80 mm)

**SATO-220** : 1.5" - 8.265" (38 mm - 220 mm)

**SATO-115** : 0.75" - 4.5" (19 mm - 115 mm)



### AXXAIR Orbital welding: tube to tubesheet

**0.4" - 3" (10 mm - 80 mm)**

Orbital welding head for tube to tube sheet applications in heat exchanger productions. Portable and easy to move machine with integrated wire dispenser. Can be used directly on worksite.

Intuitive interface and automatic parameter calculation mode integrated into the SAXX power sources range.

Quality and repeatability of welds to ensure high productivity.

## OPTIONS:



Switchbox

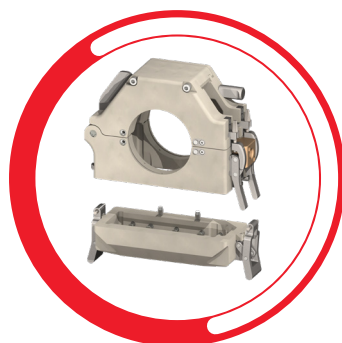

SATFX cassettes



Supports



Auto feeder



## Introduction to Pipe Purge Masters (PPM)

With the merger in 2019 of B&B Pipe and Industrial Tools LLC (USA), Mathey Dearman Inc. (USA) and TAG Pipe Equipment Specialists (UK) and the recent addition in 2022 of AXXAIR (France) into Specialized Fabrication Equipment (S.F.E.) Group, the various product groups offered by the original manufacturers have been re-aligned and integrated into the overall S.F.E. Group product range whilst keeping their own brand identity.

Backed by nearly 25 years of development, S.F.E. Group is proud to present its brand dedicated to pipe purging products, applications and solutions: **Pipe Purge Masters (PPM)**. With the PPM brand, S.F.E. Group not only wishes to highlight the focus on pipe purging products, but also supply the growing demand and diverse applications on-site, of pipe purging equipment in the industries that it already serves and intertwine with other product applications within S.F.E. Group, such as the orbital welding offered under the AXXAIR brand.

As an OEM, S.F.E. Group prides itself being renowned for its innovations, ground-breaking developments and creative designs within the Pipe Purge Masters' product range. With its engineering capabilities, customer-oriented focus and flexibility, the PPM brand provides the possibility to design out-of-the-box pipe purging solutions to fulfil customers' projects' specific needs in particular and to cater for an ever-evolving industry in general.

The PPM brand portfolio consists of a comprehensive range of pipe purging equipment: **inflatable pipe purge bag systems**, formed **double seal purge systems**, **purge oxygen monitors**, inflatable as well as mechanical **pipe stoppers** and accessories.

Pipe Purge Masters' products are available from the international S.F.E. Group branches on 4 continents, as well as from S.F.E. Group's extensive and continuously expanding global network of partners and distributors.

Get in touch for any pipe purging application.



### PIPE PURGING SYSTEMS

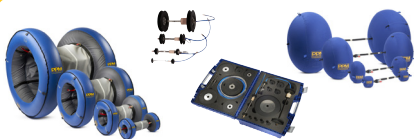

PPM's range of purge systems greatly reduces the purging time and gives significant gas savings while producing a top quality weld.

### PURGE OXYGEN MONITOR



PPM also offers a full range of weld purge monitoring systems to accurately measure the level of oxygen inside the weld chamber to obtain high quality purity welding.

### PIPE STOPPERS



In addition to the purging systems and purge monitors, PPM also offers an extensive range of pipe stoppers: inflatable stoppers available in all shapes, sizes and materials, as well as expanding stoppers available in nylon, steel and aluminium. PPM also provides tailor made pipe stopper solutions.



Heat Resistant  
up to 70°C



## PPM Purge bag systems

**2" - 24" (50 mm - 610 mm)**

Used for 90% of the traditional pipe weld purging applications to provide bright, shiny, oxide free weld roots. The PPM Purge Bag system is quick and easy to use, providing a very rapid weld purge. High quality materials are used in the production of these systems, guaranteeing perfect oxide-free weld roots in very little time.

Due to the design of this system, the volume of gas used to purge is minimized, resulting in significant reduction of both time and inert gas consumption. Return on investment can be achieved in as little as just one or two welds. These robust systems can be used over and over again paying for themselves in very little time.

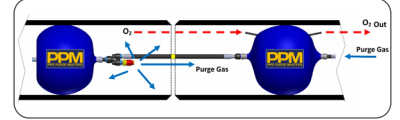

Heat Resistant  
up to 250°C



## PPM Rapid purge™ system

**8" - 80" (190 mm - 2,044 mm)**

Used for stainless, duplex, chrome steels, titanium, nickel and other alloy materials, the PPM Rapid Purge™ system enables high speed welding of larger diameter pipe joints that need to be purged. The system is designed to enable the user to produce high quality, reliable and repeatable welding of stainless steel tube and pipe joints free from oxidation and discolouration. A 36" diameter pipe will purge to below 0.1% oxygen in less than 10 minutes and all smaller pipes correspondingly faster. Due to the quality of the materials used, the Rapid Purge™ system can be used over and over again, reducing manufacturing costs. The Rapid Purge™ system has been developed specifically to enable high speed purging for any pipe welding application.

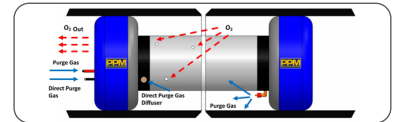

Heat Resistant  
up to 500°C



## PPM Heat resistant purging systems

**3" - 80" (63 mm - 2,044 mm)**

The PPM Purge Bag and Rapid Purge™ systems are both available in heat resistant version. They are designed to use when high temperatures will be encountered during the process of pipe welding; such as pre-heated pipework, and pipes where very high temperatures are required for welding. These versions of the inflatable pipe purging systems are heat resistant up to 350°C (662°F) for up to 24 hours, or up to 500°C (932°F) for short periods of time. The heat resistant systems are available for all pipe diameters from 3" - 80" (63 - 2,035 mm). Mirroring the features of the standard range of inflatable purging systems, the heat resistant range comes with a central luminous band for rapid centering of the system to the weld root.

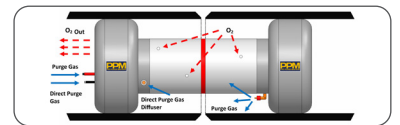

Heat Resistant  
up to 450°C



## PPM Double seal systems

**½" - 12" (16 mm - 320 mm)**

PPM also manufactures the silicone Double Seal purging system that has been designed to further reduce both inert gas use and purging time. This system uses silicon discs to form an airtight seal, reducing purge times and gas usage for maximum efficiency.

There are 2 styles of silicon Double Seal systems available:

- the Gas Finger system is designed for small pipes and tubes from 16 - 38 mm i/d
- the Double Seal system is made for pipes from ¼ - 12" (16 - 320 mm)

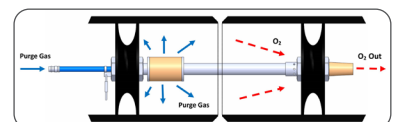

# PIPE PURGING MONITORS



## PPM Handy Purge 100SC self-calibrating weld purge monitor

**Measures oxygen down to 0.01% (100 ppm)**

Inert gas welding requires the exclusion of oxygen from the weld zone during the welding process. Prior to the welding process, the residual oxygen concentration must be reduced to a required minimum. The Handy Purge 100 is specifically designed to indicate oxygen concentration up to 0.01% and to exactly measure oxygen concentration up to 0.1%. Within this range, it is absolutely safe to weld and produce an oxygen-free weld seam (exceptions include special metals such as titanium, zirconium, etc.).

The Handy Purge 100 can be used both for continuous monitoring during the welding process and for taking samples. Routine inspections for quality control are extremely simplified using this device. The analyser works with all purge systems and argon welding systems. It is small, easy to handle and has a rugged enclosure.

# PIPE STOPPERS



## PPM Expanding pipe stoppers - nylon

**1½" - 72" (38 mm - 1,829 mm)**

Nylon plugs are the standard drain plugs for testing leak tightness of foul water lines at the time of installation. Furthermore, the range of sizes make these plugs ideal for a number of other applications in the water and gas industries as well as applications in all other industries where pipes are used or where there are holes to be blocked.



## PPM Expanding pipe stoppers - aluminium

**1½" - 24" (40 mm - 600 mm)**

To complement the range of nylon expanding plugs, we offer all sizes of aluminium plugs. These are provided in sizes from 1½" (40 mm) upwards and are suitable for more heavy duty applications, heat resistant up to 90°. These plugs are typically used for general sealing of pipes and purging.



## PPM Expanding pipe stoppers - steel

**1½" - 36" (40 mm - 900 mm) (Larger sizes available upon request)**

PPM also manufactures a range of steel plugs from 1½" (40 mm) upwards in diameter. These plugs are typically suitable for more heavy duty applications, heat resistant up to 90°. These plugs are typically used for general sealing of pipes and purging.

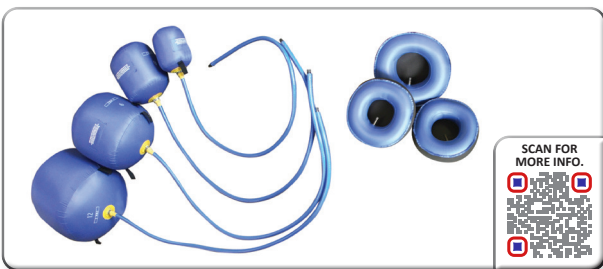

## PPM Inflatable pipe stoppers

**2" - 80" (50 mm - 2,035 mm)**

PPM offers a range of inflatable stoppers in various shapes and sizes, suitable for many applications. Made from a natural rubber bladder covered in waterproof polyurethane coated nylon to prevent friction and static electricity build up.

There are six different types available: cylindrical; spherical; square / rectangular; doughnut; sausage and heat resistant.

# FIT-UP PRO

By Mathey Dearman

## Introduction to Fit-Up Pro

With the merger in 2019 of B&B Pipe and Industrial Tools LLC (USA), Mathey Dearman Inc. (USA) and TAG Pipe Equipment Specialists (UK) and the recent addition in 2022 of AXXAIR (France) into Specialized Fabrication Equipment (S.F.E.) Group, the various product groups offered by the original manufacturers have been re-aligned and integrated into the overall S.F.E. Group product range whilst keeping their own brand identity.

With having Mathey Dearman supplying pipe fit up tools since the 1930's, S.F.E. Group is proud to present its brand dedicated to one of its most historical product ranges: **Fit-Up Pro by Mathey Dearman**.

With the Fit-Up Pro brand, S.F.E. Group not only wishes to highlight the focus on fit up, alignment and layout tools, but also supply the growing demand and diverse applications on-site in the industries that the S.F.E. Group already serve and intertwine with the other product applications within S.F.E. Group.

As an OEM, S.F.E. Group prides itself being renowned with the Fit-Up Pro brand not only for its history in pipe fitting tools, but also for the continuous innovations and the overall comprehensiveness of this range of fit up, alignment and layout tools, including: external and internal **pipe clamps**, welding **wedges**, **flange spreaders** and **flange aligning tools** and a wide variety of **pipe layout and marking tools**.

Fit-Up Pro's products are available from the international S.F.E. Group branches on 4 continents, as well as from S.F.E. Group's extensive and continuously expanding global network of partners and distributors.

**Get in touch for any pipe fitting and pipe aligning application.**

### FIT-UP AND ALIGNMENT TOOLS



Our spider clamps are great for flange fit up and we also offer other types of alignment pipe clamps that save time and increase productivity. Two hole pins, flange alignment bolts and stepped wedges are also time savers that compliment this line, along with various squares and protractors. We even offer two types of flange spreaders, (manual and hydraulic) that assist in safe maintenance and preparation for re-fit of flanges.

### LAYOUT AND MARKING TOOLS



Fit-Up Pro offers several tools specific to pipe layout. A new pocket level and fitters torpedo level are made from aircraft aluminium balancing light weight and durability. A newly designed pipe centering tool adds magnets for hands free use and comes with a right angle square and handy ruler markings, and our line of radius markers is great for laying out a radius or circles up to 100 inches.

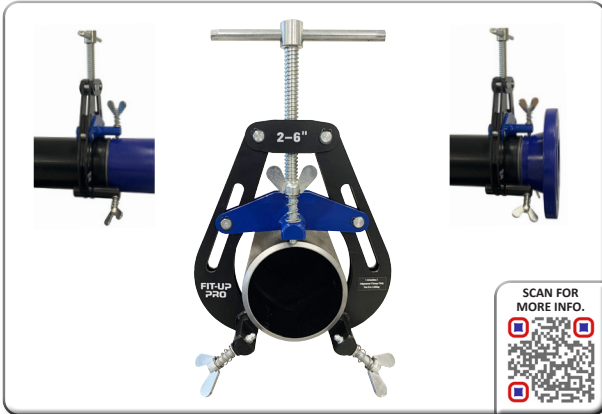

## FIT-UP PRO Quick fit PDQ pipe clamps

**1" - 14" o/d**

This classic design high-low alignment clamp has been in used worldwide for years.

With a durable, yet cost effective fabricated design, the PDQ pipe clamps fit up to 14" pipe and are available in three sizes.

The new Quick-Fit PDQ pipe clamps can be used on stainless steel without any additional accessories due to the stainless steel feet and balls in the wing-nuts, preventing contamination of the pipe.

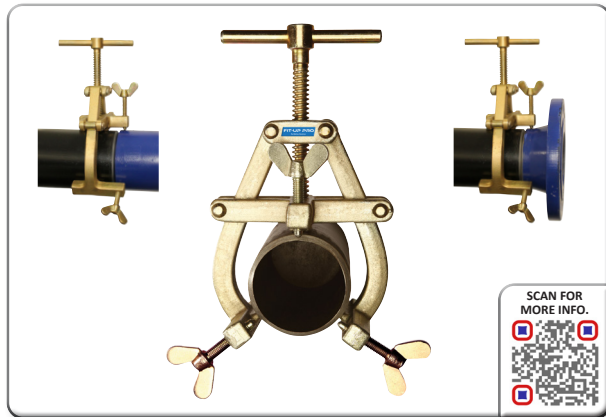

## FIT-UP PRO E-Z fit gold pipe clamps

**1" - 14" o/d**

This classic design high-low alignment clamp has been in used worldwide for years. The heavy-duty design utilises forged steel, galvanised to offer protection to ensure a robust product.

With a durable, yet cost effective fabricated design, the E-Z Fit Gold pipe clamps fit up to 14" pipe and are available in five overlapping sizes.

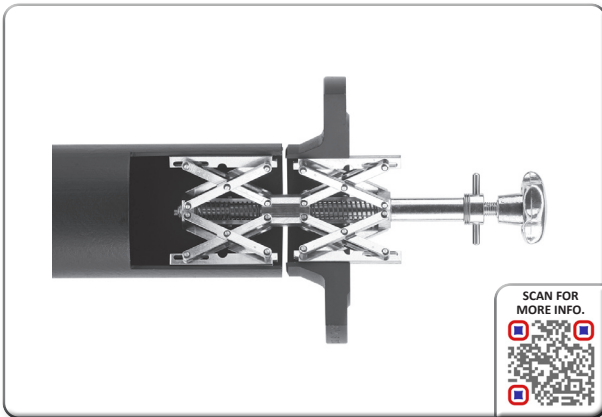

## FIT-UP PRO E-Z fit spider internal clamps

### Spider clamp - Series 400

**2" - 36" (54 mm - 940 mm) i/d**

This model has two independent expanding clamps, allowing independent alignment of two hollow cylindrical components of different diameters. The bottom expanding clamp is inserted and clamped in the pipe by means of the knob. Then the other part (e.g. a flange) is placed over the top expanding clamp and clamped by means of the hand-bar. This model is specially suited for heavy parts. All locating rails are in stainless steel.



## FIT-UP PRO E-Z fit spider internal clamps

### Elbow spider clamp - Series 500

**2" - 20" (54 mm - 520 mm) i/d**

This model with two independent clamps is used for clamping flanges of all kinds and similar parts to elbows and pipe-bends of various diameters. The lower expanding clamp has strong gripping feet which insert into the bend and are tightened by means of the knob. The top expanding clamp is tightened by means of the handbar in the flange.

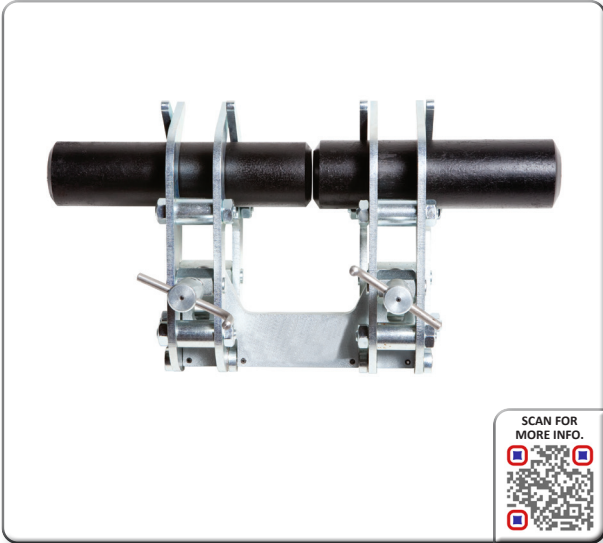

## FIT-UP PRO E-Z Fit spider internal clamps

### Scissor clamp - Series 100

**1/8" - 12" (10 mm - 330 mm) i/d**

For quick and accurate alignment of pipes of equal or differing diameters on a common centre line. Automatic diameter compensation. There's no need to make additional adjustments. All parts stay easily accessible for welding.



Clip to belt or hang in tool box.

## FIT-UP PRO Spacing wedges

When using Mathey Dearman clamps, spacing wedges enable better fit-up of pipe ends. Wedges are used to create precise weld gaps.

Simply move the pipe ends together, mount and tighten the chain clamp or cage clamp and spread the gap to the desired width using the spacing wedge.

The wedge portion of the spacing wedge is case hardened for long life, while the upper part of the wedge is soft enough to prevent splintering.

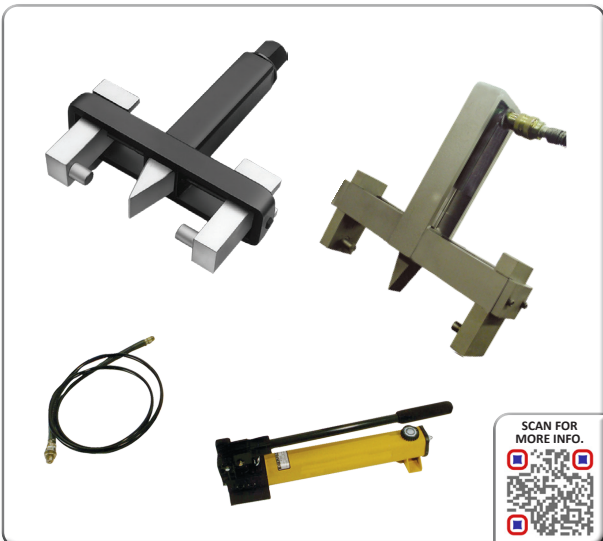

## FIT-UP PRO Flange spreader

Flange spreaders separate flanges safely and easily without hammering. The spreader, which attaches to the flange holes, spreads the flange faces without damaging flange sealing surfaces. The wedge action of the spreader widens the gap between flanges up to 1/4" (32 mm). 100 ft.-lbs. of torque applied to the flange spreader yields up to 12,000 lbs. of spreading force.

Hydraulic flange spreaders are available for 2" - 36" (51 - 914 mm) flanges and use a hydraulic pump kit (sold separately) to easily separate flanges.





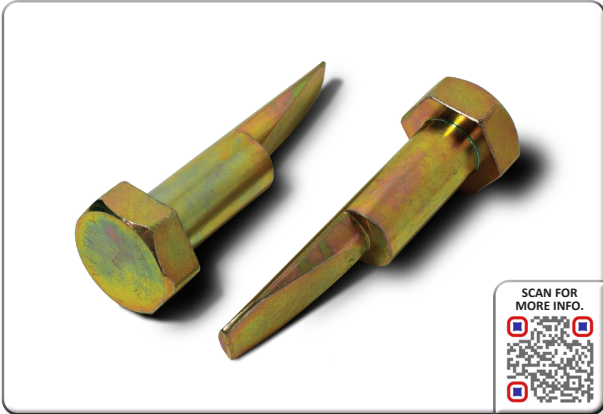

### FIT-UP PRO Flange alignment bolts (FAB Bolts)

Safe, fast, and effective solution for even the toughest flange alignment jobs. The tool's tapered shaft eliminates hammering and prying when lining up flange bolt holes.

**Safer:** Eliminates the need for wedges or hammers.

**Protects:** Greatly reduces risk of damage to the flange.



### FIT-UP PRO Push-button carbon steel flange line up pins

Introducing the latest addition to our Flange Line Up Pins (FLUP) range, our new push-button carbon steel model. The new flange line up pin installs and removes quickly thanks to its convenient push-button operation. Rugged ACME-thread and rust-resistant black oxide coated carbon steel means you can expect years of reliable use.

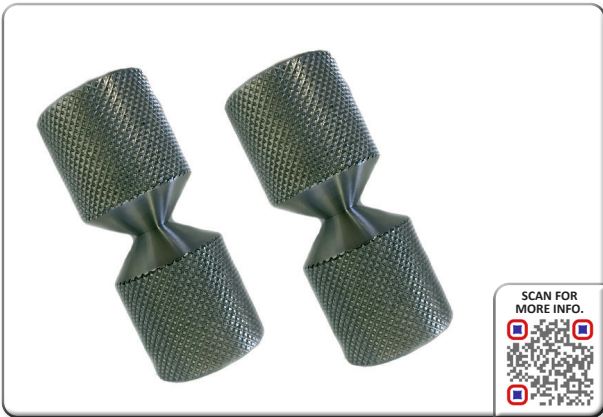

### FIT-UP PRO Stainless steel flange pins

Fit-Up Pro stainless steel flange pin, aka "two hole pins" are used for precise flange leveling and alignment. The PN 2124 are smaller stainless steel mini pins that fit flange holes up to 3/8". The knurled surfaces are an additional feature that allow snug flange hole fitting that increases accuracy during flange alignment.



### FIT-UP PRO Rotary earth clamp

A simple yet effective device eliminates earth lead twisting, tangling and unnecessary wear.

Provides a stable earth for circumferential welding of pipes and fittings and eliminates weld pinholes caused by poor earthing. Anti-arc bearings take loads of up to 400 amps.





**FIT-UP PRO Centering head**

The Fit-Up Pro D206 centering head is a precision tool, useful for finding pipe centerlines, establishing angles or points around pipes, shafts, tanks or other cylindrical surfaces. The rotating protractor dial is marked in 2.5° increments for precise point location. The centering head is designed for use on cylindrical surfaces from 3" to 40" in diameter.



**FIT-UP PRO Pocket level**

The robust aluminium construction, rotating dial and magnetized base makes this tool a handy must-have for all tradesmen.



**FIT-UP PRO Torpedo level**

The Fit-Up Pro torpedo level is a must have for the pipe fabricator offering multiple features. Magnets adhere the level to the pipe, while a rotating degree dial makes angle verification easy. Two fixed dials make common fit ups easy.

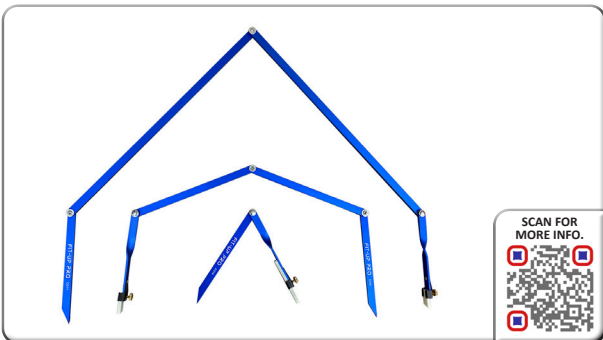

**FIT-UP PRO Radius marker**

Robust construction and tensioned, yet easy to move, joints make this the perfect precision tool for all welders and fitters. Lay out saddle cuts, circles, half round, oval or elliptical cuts with confidence.

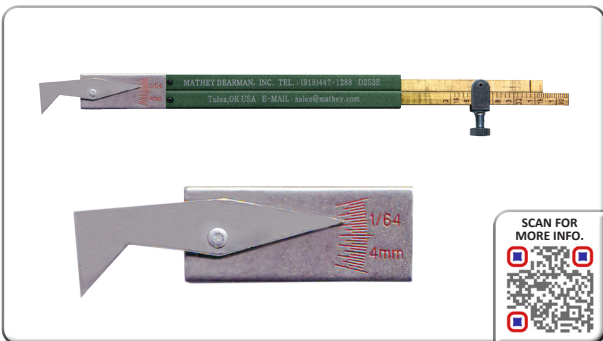

**FIT-UP PRO Q.C. Welder with pit depth gauge**

The Q.C. welder with pit depth gauge measures pit depth, weld height and outside "high-low". The stainless steel pit depth gauge mounts on the end of the Q.C. welder's gauge housing and displays in English measurements.





## FIT-UP PRO Pipe wrap

Fit-Up Pro by Mathey Dearman pipe wrap has double-ruled edges so it is never upside down or backwards. The wrap can be used as a straight edge to mark straight lines around the pipe and to mark angles for pipe elbows. The pipe wrap is constructed of highly abrasion and solvent resistant materials to last under heavy use.

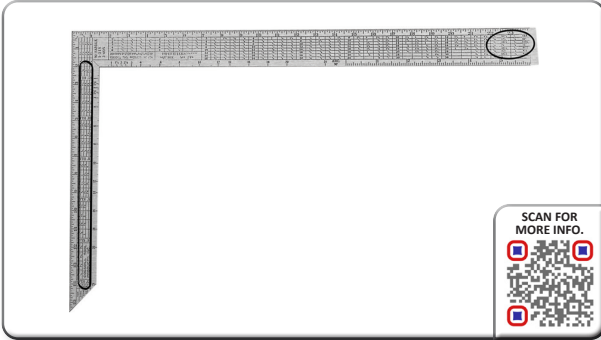

## FIT-UP PRO Pipe fitter's square

The stainless steel pipe fitter's square is the only precision square designed specifically for pipefitters, boilermakers, welders and layout persons.

After becoming familiar with the scales and tables of the square, many complex problems encountered during pipe fit-up and layout work are easily solved.

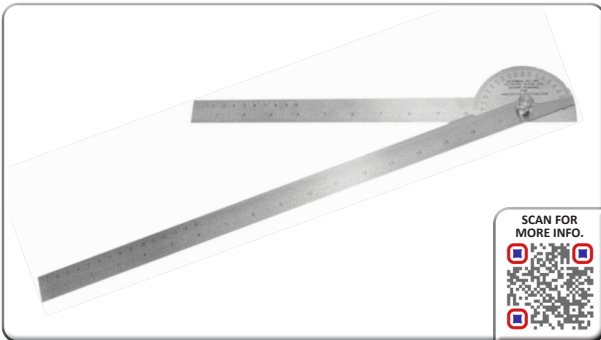

## FIT-UP PRO Protractors

The large protractor will measure squareness of pipe ends up to 40" / 1,016 mm diameter or can be used to check large pipe miter angles up to 180°. Leg lengths of 48" / 1,219 mm and 36" / 194 mm.

The small protractor is an excellent tool for sheet metal layout, checking squareness of pipe ends up to 17" / 432 mm diameter. It has a large 18" / 457 mm leg, a shorter 12" / 305 mm leg and it is accurate to  $\pm 1^\circ$ .

The mini protractor can be used for a variety of applications including measuring bevel angle.

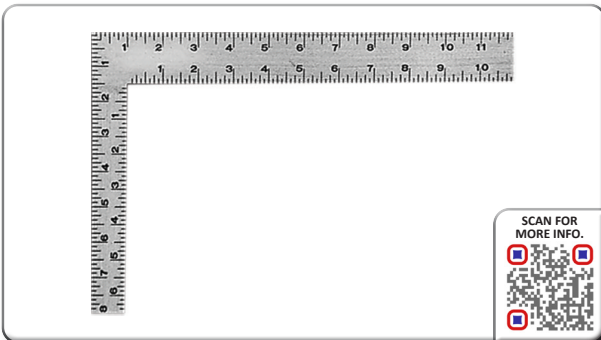

## FIT-UP PRO Framing square

The small stainless steel framing square measures angles, squareness, and finds pipe's centerline.

When used with a level, the square measures drops in inches per foot to determine slope. The square is marked in  $\frac{1}{8}$ " increments.

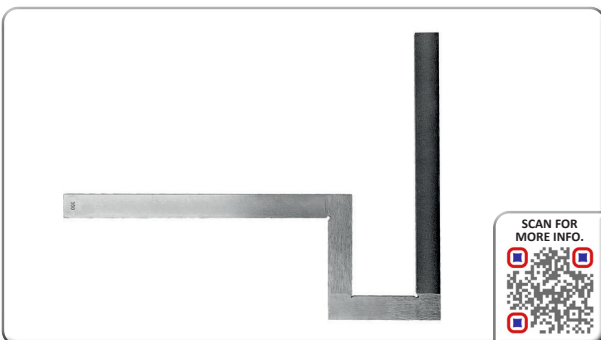

## FIT-UP PRO Flange square

Designed for the precise adjustment of flanges in tube/pipe construction.





**SPECIALIZED FABRICATION EQUIPMENT GROUP**

## Global Locations:



### UNITED STATES HEAD OFFICE - HOUSTON

**SPECIALIZED FABRICATION EQUIPMENT GROUP**

4433 South Drive,  
Houston,  
Texas 77053, USA

Tel: +1 713 747 8502

E-mail: [sales@sfe-brands.com](mailto:sales@sfe-brands.com)

### INTERNATIONAL HEAD OFFICE - FRANCE

**SPECIALIZED FABRICATION EQUIPMENT GROUP**

330B Route de Portes Les Valence,  
ZI les Bosses,  
26800 Etoile-sur-Rhône, France

Tel: + 33 (0) 475 575 070

E-mail: [sales-int@sfe-brands.com](mailto:sales-int@sfe-brands.com)

#### SFE UNITED KINGDOM

**SPECIALIZED FABRICATION EQUIPMENT GROUP**

Unit 15 & 16 Grendon Industrial Estate,  
Grendon Underwood, Aylesbury,  
Buckinghamshire, HP18 0QX England

Tel: +44 (0)1869 324 144

E-mail: [sales-uk@sfe-brands.com](mailto:sales-uk@sfe-brands.com)

#### SFE GERMANY

**SPECIALIZED FABRICATION EQUIPMENT GROUP**

Ostmarkstrasse 15,  
76437 Rastatt,  
Germany

Tel: +49 (0)7222 9355100

E-mail: [sales-germany@sfe-brands.com](mailto:sales-germany@sfe-brands.com)

#### SFE KINGDOM OF SAUDI ARABIA

**SPECIALIZED FABRICATION EQUIPMENT GROUP**

Warehouse No: EM16-10, Air Base Determinant,  
Industrial supply scheme, Ash Shulah, Dammam  
34264, Saudi Arabia

Tel: + 966 50 515 8196

E-mail: [sales-ksa@sfe-brands.com](mailto:sales-ksa@sfe-brands.com)

#### SFE MIDDLE EAST

**SPECIALIZED FABRICATION EQUIPMENT GROUP**

Shams Freezone  
Sharjah

United Arab Emirates

Tel: +971 (0)50 217 1376

E-mail: [sales-me@sfe-brands.com](mailto:sales-me@sfe-brands.com)

#### SFE INDIA

**SPECIALIZED FABRICATION EQUIPMENT GROUP**

Plot No. PAP 3, D 3 Block,  
Chinchwad, Pune 411 019

Mob: +91 90 1102 4332

Mob: +91 95 5258 4361

E-mail: [sales-india@sfe-brands.com](mailto:sales-india@sfe-brands.com)

#### SFE LATIN AMERICA

**SPECIALIZED FABRICATION EQUIPMENT GROUP**

4433 South Drive,  
Houston,

Texas 77053, USA

Tel: +1 713 747 8502

E-mail: [sales-latam@sfe-brands.com](mailto:sales-latam@sfe-brands.com)

#### SFE SOUTH KOREA

**SPECIALIZED FABRICATION EQUIPMENT GROUP**

102 - 1301 Bucheon Technopark III  
421 - 742 Gyeonggi-do-seoul, Taehan-min'guk  
South Korea

Tel: +82 32 624 2870

E-mail: [sales-asia@sfe-brands.com](mailto:sales-asia@sfe-brands.com)

#### SFE VIETNAM

**SPECIALIZED FABRICATION EQUIPMENT GROUP**

P1.2.13 Sky-Linked Villa, Diamond Alnata,  
Celadoncity, 89 Đường N1, P. Sơn Kỳ,  
Q. Tân Phú, TpHCM.

Tel: +84 91 951 70 18

E-mail: [sales-vietnam@sfe-brands.com](mailto:sales-vietnam@sfe-brands.com)

#### SFE CHINA

**SPECIALIZED FABRICATION EQUIPMENT GROUP**

1208, 12F, #D 7001 Zhongchun RD  
Minhang District  
Shanghai, China

Tel: +86 215 429 1891

E-mail: [sales-china@sfe-brands.com](mailto:sales-china@sfe-brands.com)

Copyright © 2023 Specialized Fabrication Equipment Group, All rights reserved.

## OUR BRANDS

